

ALL AMERICAN

SCOREBOARDS™

OPERATING INSTRUCTIONS AND SERVICE MANUAL
 BASKETBALL SCOREBOARD
 (with Wrestling and Volleyball Capabilities)

MODEL MP-5214 WITH MP-5000 CONTROL

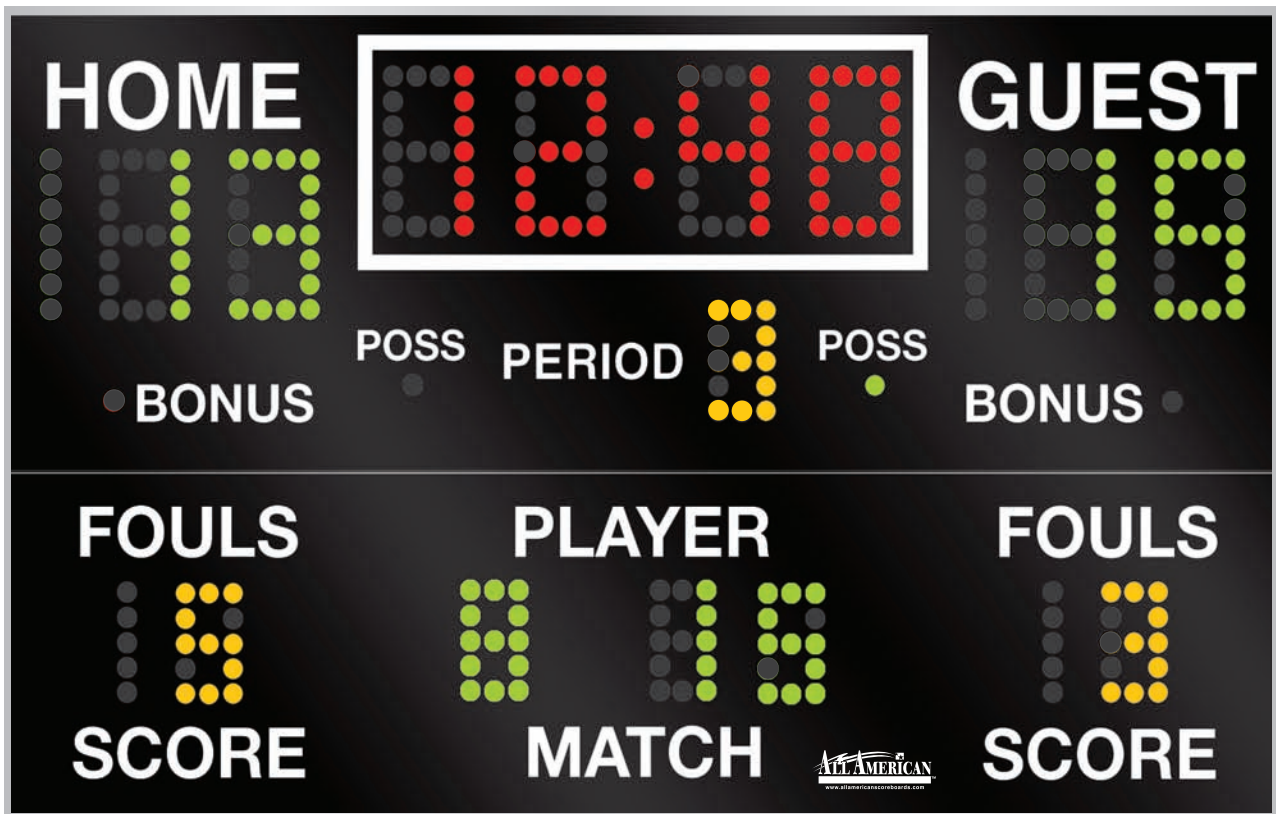

TABLE OF CONTENTS

1. GENERAL INFORMATION

- 1.1 DESCRIPTION
- 1.2 IDENTIFICATION
- 1.3 DAMAGE
- 1.4 DAMAGE CLAIM PROCEDURE

2. INSTALLATION

- 2.1 GENERAL INFORMATION
- 2.2 INSPECTION
- 2.3 PRE-TEST
- 2.4 DATA CABLE INSTALLATION
- 2.5 ELECTRICAL CONNECTIONS

3. CONTROL CONSOLE OPERATION

- 3.1 SCOREBOARD POWER
- 3.2 CONSOLE DISPLAY
- 3.3 CONSOLE POWER
- 3.4 TO USE SCOREBOARD
- 3.5 SETUP
- 3.6 TIMING
- 3.7 TEAM SCORES
- 3.8 HORN
- 3.9 BONUS INDICATOR
- 3.10 PERIOD INDICATORS
- 3.11 TIMEOUT PERIOD
- 3.12 TIME OUTS LEFT
- 3.13 BALL POSSESSION INDICATOR
- 3.14 SLIP SHEET LAYOUT

4. MAINTENANCE AND TROUBLESHOOTING

- 4.1 INTRODUCTION
- 4.2 TEST EQUIPMENT
- 4.3 TROUBLESHOOTING
- 4.4 TROUBLESHOOTING GUIDE

5. REPLACEMENT PARTS LIST

- 5.1 SCOREBOARD DISPLAY PARTS
- 5.2 CONTROLLER ASSEMBLY PARTS
- 5.3 POWER SUPPLY PARTS

6. DIAGRAMS

- 6.1 CONTROL CONSOLE KEYBOARD AND REPLACEMENT PARTS LIST
- 6.2 SCOREBOARD SYSTEM LAYOUT
- 6.3 SINGLE WALL JUNCTION BOX WIRING DIAGRAM (C-12675-2)
- 6.4 DUAL WALL JUNCTION BOX WIRING DIAGRAM (C-12675-3)
- 6.5 CONTROLLER WIRING DIAGRAM
- 6.6 POWER SUPPLY DIAGRAM
- 6.7 RECEIVER BOARD DIAGRAM
- 6.8 DRIVER BOARD DIAGRAMS
- 6.9 MICROPROCESSOR 4 X 7 LED PATTERN (8 BIT)
- 6.10 INSTALLATION DRAWING

1. GENERAL INFORMATION

1.1 Description

Your All-American scoreboard has been carefully inspected and tested before leaving the factory. It is possible, however, that components may be loosened or forced out of adjustment in transit. If this occurs, follow the troubleshooting guide (section 4). If equipment then fails to operate, Contact immediately:

ALL-AMERICAN Service Department
EVERBRITE LLC
P.O. Box 100
Pardeeville, WI 53954
Telephone: (608) 429-2121
Toll Free: 800-356-8146
E-mail score@everbrite.com

Parts being returned for repair are to be sent to:

ALL-AMERICAN Service Department
EVERBRITE LLC
P.O. Box 100, 401 S. Main Street
Pardeeville, WI 53954

NOTE:

If you need to send parts in for repair, please call the ALL AMERICAN service department for a returned goods authorization (RGA) number.

1.2 Identification

The serial number tags are located on the back of the control console and the lower right hand Corner on the face of the scoreboard display. When contacting the factory for assistance it is important that the model number and serial number are known.

1.3 Damage

Upon receipt of scoreboard, check for visible damage. If this occurs, or if damage is found after shipment has been accepted, follow the damage claim procedure.

1.4 Damage Claim Procedure

An instruction sheet is enclosed advising the consignee in case of damage in transit. If damage is noted at the time of delivery, consignee must obtain an 'Inspection of Bad Order' from the delivering carrier. In order to process your claim, this must be properly filled out with a complete statement of all damage and it must be signed by the carrier. If damage is discovered after delivery,

you should call the delivery company. Have them make out a Concealed Damage Report. Fifteen days after delivery are allowed, so this should be done promptly or it is impossible to process this claim.

Advise EVERBRITE corporation of necessary replacement parts or repairs.

Consignee will be invoiced and then should file a claim with the carrier to recover charges.

To file your claim follow this procedure:

- (A) Cost of replacement parts or repair charges are invoiced to the carrier by the consignee.
- (B) The following documents, properly filled out, plus invoice, are forwarded to the trucking company in support of your claim:
 - (a) Original bill of lading
 - (b) Original paid freight bill
 - (c) Certified copy of original invoice
 - (d) Standard form for presentation of loss and damage claim

2. INSTALLATION

2.1 General Information

Shipping papers accompany each scoreboard. Check carefully to see that you receive the following:

- 1 ea Basketball Display
- 1 ea Control Console
- 1 ea Manual
- 1 ea Wall Junction Box (Radio Only)
- ? ft Control Cable (if ordered)

IMPORTANT!

The MP-41 cable supplied by ALL AMERICAN SCOREBOARDS for use on the Microprocessor based scoreboards is specifically designed for this system. Use of a substitute cable may void the warranty on the scoreboard

2.2 Inspection

Inspect each unit and tighten all screws and fittings that may have loosened in shipment.

2.3 Pre-Test

Before installing the scoreboard, pre-test all functions.

- (A) Connect the scoreboard to a 15 AMP, 120 Volt AC circuit.
- (B) Plug the control console into the top of the scoreboard.
- (C) Test operate all functions on the scoreboard according to operating instructions in section 3 of this manual.
- (D) When all the functions test out, disconnect the power and the control console before hanging the scoreboard.

2.4 Data Cable Installation

The MP-41 data cable carries only low voltage signals and therefore can be installed with or without conduit. Consult section 6 for junction box and scoreboard wiring.

2.5 Electrical Connections

This scoreboard requires a 120 V. 15 AMP AC circuit for the exclusive use of the scoreboard. If You want

to be able to turn the scoreboard off when not in use, by means other than turning off the circuit breaker, a disconnect switch (NOT SUPPLIED) must be installed by the installer or an electrician.

NOTE !

To protect the control from damage, it is advisable that you disconnect the control and store in a dry secure area when not in use.

NOTE

This equipment is **UL** approved and complies with the requirements in part 15 of the FCC rules for a class A computing device. Operation of this equipment in a residential area may cause unacceptable interference to radio and television reception, requiring the operator to take whatever steps are necessary to correct the interference.

3. CONTROL CONSOLE OPERATION

3.1 Scoreboard Power

Turn on the branch circuit to the scoreboard. The scoreboard will blank all figures.

3.2 Console Display

The 2 line by 20 character Liquid Crystal Display module displays the scoreboard information Entered from the keyboard. The following information is displayed during normal operation: Time, Home and Guest scores, Period, Home and Guest Bonus, Ball Possession, Auto Horn Enable, and 1/10 Second Enable.

3.3 Console Power

Plug the hand held remote control into the scoreboard control console if you have a hand held Time control.

Plug the control console into the wall junction box.

Push  once to turn the console on.

Push  a second time to shut the console off.

When first turned on; the console display should show as follows;



MULTISPORT CONTROL
MP-5000 VER X.XX 20XX

3.4 To Use Scoreboard

Enter the two digit code (**58**) shown in the upper right corner of the keyboard as in the

following example: Push  then   then .

(58 for Basketball, 51 for Basketball with Shotclocks, 60 for Wrestling, 70 for Volleyball)

When the proper code has been entered, the console LCD will show as follows.

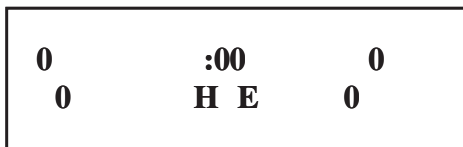

0 :00 0
0 H E 0

Home and Guest scores will now show "0", and the timer will show ":00".

3.5 Setup

The **SETUP** key will step through a list of operational settings.

Press **YES/NO** or make Numeric Entries to make changes.

Pushing **ENTER** without any other input skips to the next item.

Pushing **CLEAR** exits setup and all changes are kept.

Select brightness level for the scoreboard digits by pushing 1-8 and **ENTER**.

Select game time period. Example, 800 and press **ENTER** for 8 minutes.

Select time out length. Example, 100 and press **ENTER** for 1 minute.

Select time outs allowed. Example, 3 and press **ENTER** for 3 time outs.

Select automatic horn for end of period. Example, Yes/No and press **ENTER**.

Select 1/10 second timing for the last minute of play. Example, **YES/NO** and press **ENTER**.

Select set time of day clock. Example: Press **2 1 5** then **ENTER** for 2:15.

The Scoreboard will display the time of day after game time use, if desired.

Accurate time will be kept without power to the scoreboard for up to 2 months.

3.6 Timing

The main game time period is set in the **SETUP** Program, however this time period may be changed or edited using the **EDIT TIME** key.

To change the period time; Push, **EDIT TIME**, the desired time period, then **ENTER**.

To reset the period time to the original setting; Push **TIME RESET**.

To change the time period directional mode for counting up or down; Push **UP/DOWN**.

When in the Up mode, an arrow up symbol is displayed next to the time on the LCD display.

If in the Down mode, there is no arrow displayed.

3.7 Team Scores

The Home and Guest Scores can be changed in five different ways.

(E) To add 1 to the existing score: Push **+1**.

(F) To add 2 to the existing score: Push **+2**.

(G) To add 3 to the existing score: Push **+3**.

(H) To directly enter or correct a score: Push Home or Guest **SCORE**, followed by the desired number, then **ENTER**.

Example: Present Home Score is 15. Change the score from 15 to 23.

Push: Home **SCORE** then **2** **3** then **ENTER**.

(E) To clear the score: Push **SCORE** then **CLEAR**.

3.8 Horn

The horn will blow each time **HORN** is pressed.

The horn will blow automatically at the end of each period for 2 seconds, if selected in the setup mode.

An 'H' is displayed on the LCD when this function is enabled.

3.9 Bonus Indicators

Push Home or Guest **BONUS** to illuminate the appropriate bonus indicator. A '<B' or 'B>' will be displayed when the bonus is illuminated.

3.10 Period Indicators

Push **PERIOD** once, to increment the period indicator. The LCD display will show the Period directly below the time.

3.11 Timeout Period

An automatic timeout period is selected in the setup mode, and is provided for "Time Outs" when the main timer is not running.

Push **TIME OUT TIMER** to start the 1 minute timer. The LCD will show

"TIME OUT = 1:00" and start to count down. When 1 minute has elapsed the internal beeper sounds, and the display returns to the current game time.

If you want to return to play before the Time Out Timer gets back to zero,

push **TIME OUT TIMER** then **CLEAR**, and the console will return to play mode.

3.12 Time Outs Left

The Time Outs allowed per game for each team are selected in the setup mode.

If, at Time Out, you push home or guest **TIME OUT**, it will start the time out timer and subtract a time out from the home or guest team. At the end of the selected time out period the LCD will go to game time and be ready to go. If you wish to start the game again before the

one minute time out period ends, just push **TIME OUT** then **CLEAR**, and the LCD will again go to the game display.

3.13 Ball Possession Indicator

The ball possession indicators alternate with each **BALL POSS** entry.

The possession is displayed on the LCD with a '<P' or 'P>' to show Home or Guest possession. Push **BALL POSS** then **CLEAR** to clear both possession symbols.

3.14 Slipsheet Layout

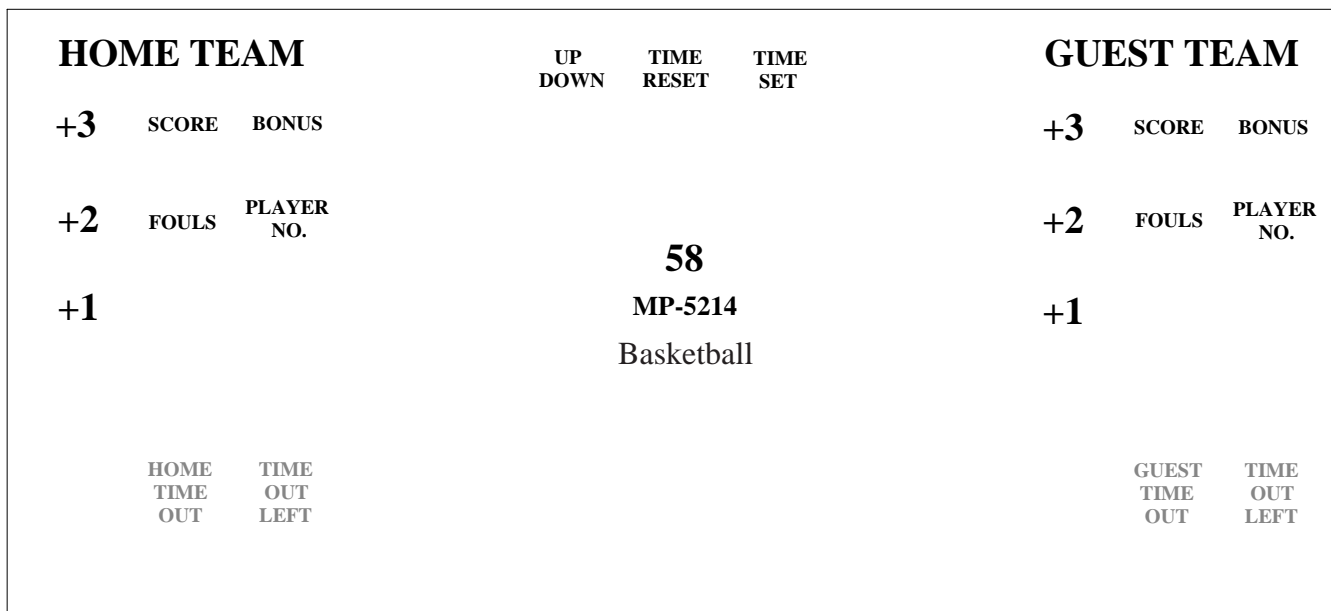
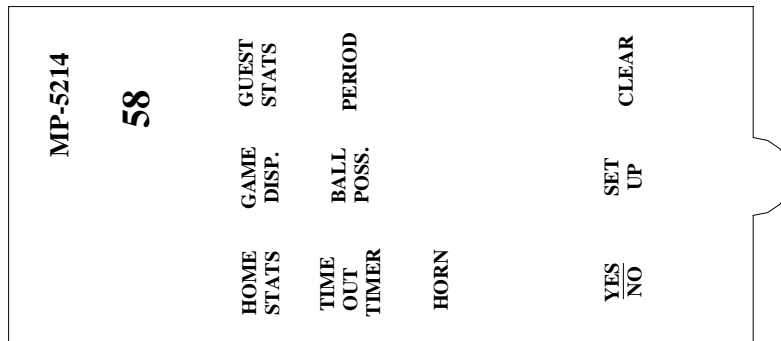

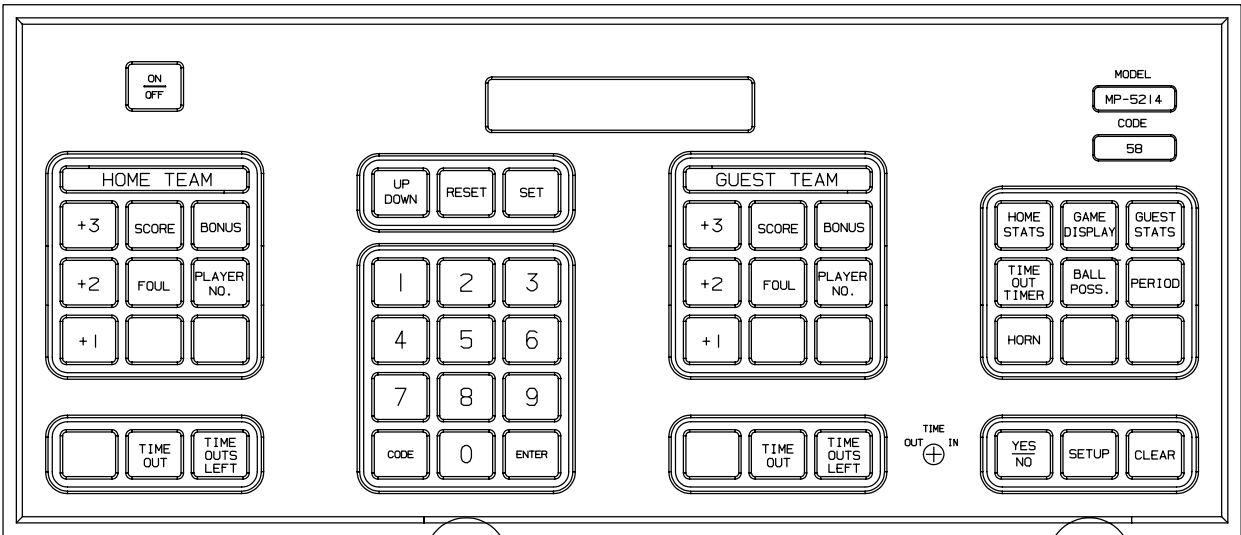

for Basketball Operation

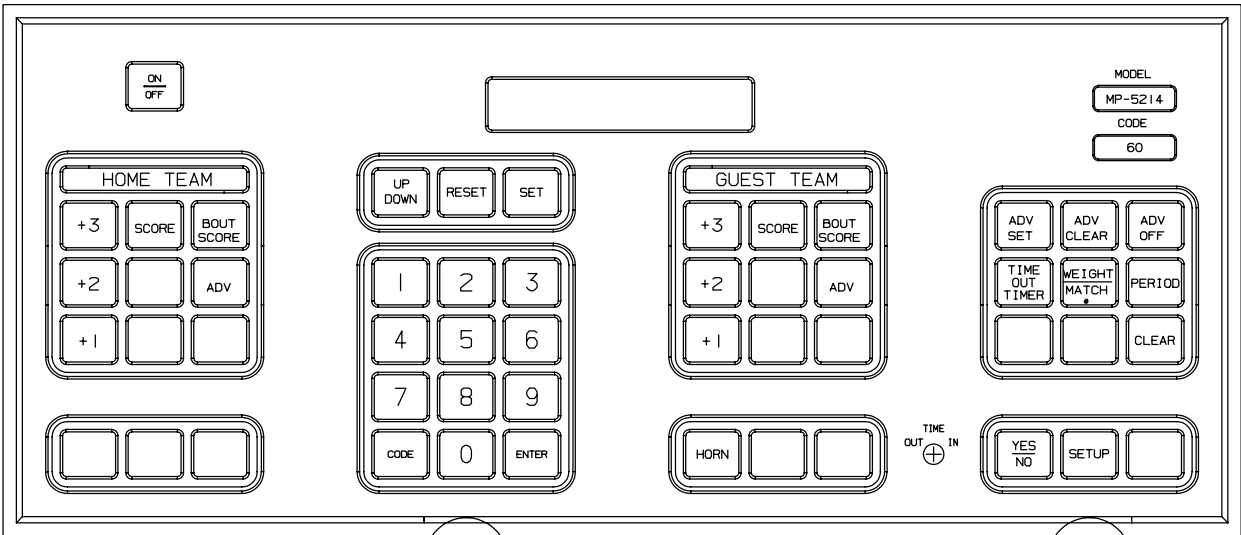

for Wrestling Operation

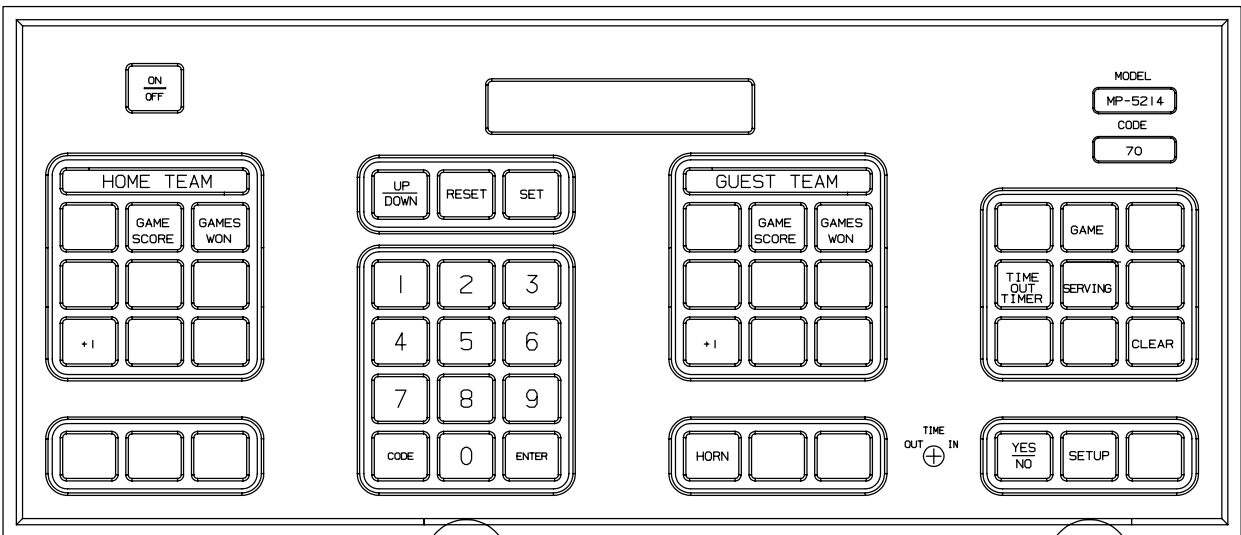

For Volleyball Operation

4. MAINTENANCE AND TROUBLESHOOTING

4.1 Introduction

This section gives maintenance and troubleshooting information. Included are troubleshooting Guides for typical scoreboard malfunctions. If the cause of a problem cannot be determined, please contact the customer service department.

4.2 Test Equipment

A simple analog or digital voltmeter will be sufficient for all user repairable problems. Printed circuit boards requiring troubleshooting should be returned to the factory.

WARNING !!!

120 VAC wires are exposed whenever the cover over the power supply assembly is removed from the scoreboard. Use extreme caution during troubleshooting or repair. To avoid possible damage to equipment or personal injury, always turn off the main power before removing the cover or replacing assemblies.

4.3 Troubleshooting

Whenever possible, follow the troubleshooting guides prior to contacting the customer service department. If a problem not described in the guides exists, contact the customer service department immediately. Refer to the diagrams provided for assistance in troubleshooting scoreboard malfunctions.

4.4 Troubleshooting Guides

(A) Scoreboard doesn't light and console doesn't work

- (a) Check that the main power switch is turned on.
- (b) Replace any defective or blown fuses.
- (c) Check the power connections and voltages at the scoreboard.
- (d) Check to see that the Green LED on the power supply is lit.
- (e) Check for 12 VDC at the power supply terminal.
- (f) Contact the customer service department.

(B) The scoreboard digits light but the console doesn't work

- (a) Check for continuity between the scoreboard and the junction box.
- (b) If an open circuit is found, the problem is either the cable or a cable connection.
- (c) If the continuity test checks good, check the voltage between the red wire and the black wire in the junction box, using a voltmeter set on the 12 VDC or higher scale.

If the voltage is 10 VDC or greater contact the customer service department.

If the voltage is 0 VDC, plug the control console directly into the top of the scoreboard.

If the control works from the top of the scoreboard, recheck all cable connections and check continuity again.

If the control still does not work, check the cable connections to the receiver board (red and black wires).

If the voltage is less than 10 VDC consult the wiring instructions for long cable Compensation (modify for AC adaptor).

If the voltage is 10 VDC or higher contact the customer service department.

(C) The scoreboard digits light, the console works, but there is no control of the scoreboard.

(a) With the main power switch "off"; remove the cover over the power supply and receiver.

(b) Check all connections.

(c) Turn the main power on.

(d) Turn the control console on and enter the code.

If LED D1 on the receiver board is flashing rapidly call the customer service department.

If LED D1 on the receiver board is not flashing, plug the control console directly into the top of the scoreboard.

If LED D1 on the receiver board flashes now check the junction box and data cable for continuity (green and white wires).

If LED D1 on the receiver board still does not flash, call the customer service department.

(D) Scoreboard digits don't light, but the console works

(a) With the main power switch "off"; remove the cover over the power supply and receiver.

(b) Check all connections.

(c) Turn the main power on.

(d) If the scoreboard still doesn't light, check the voltage between the positive and negative terminal strips on the power supply for 12 VDC with a voltmeter set on the 12 VDC or higher scale.

If the voltage is 12-13 VDC, go to (e).

If the voltage is less than 12 VDC check the power supply input voltage for 120 VAC and contact the customer service department.

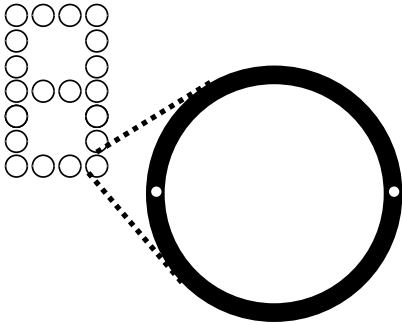

1. Find Faulty Cluster

After bad cluster is identified, disconnect power from scoreboard. Make sure to note the color of the cluster.

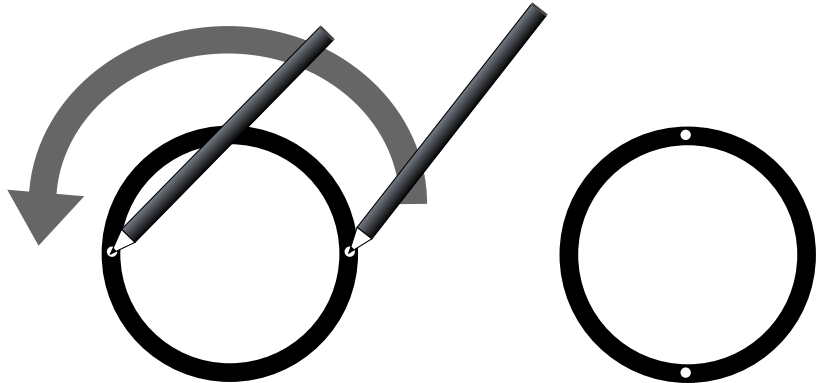

2. Unlock Cluster

Unlock by using 2 ball point pens (or strong objects able to fit into turning holes), turn cluster 1/4 turn. The cluster can be removed once the holes are lined up vertically (12 & 6 O'Clock).

NOTE: Use caution when turning the cluster to avoid slipping and scratching the face of the scoreboard.

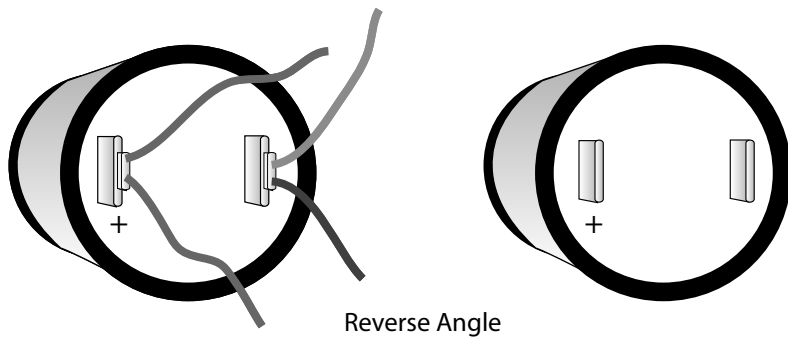
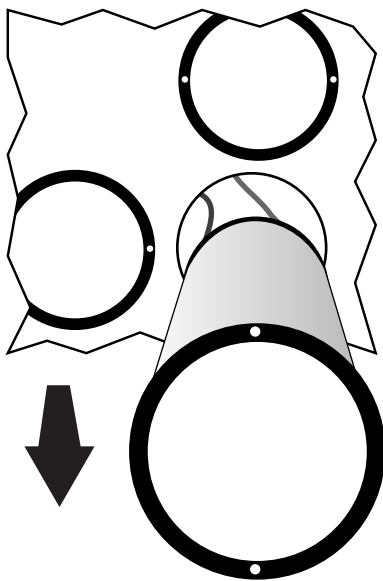

4. Disconnect Wires From Cluster

Take note of the connections on the back of the cluster prior to removal. A "+" marks the positive connection (connected to at least 1 red wire). Gently pull the female connectors from the back of the cluster and remove cluster.

3. Remove Cluster

Gently pull cluster to gain access to the wire connectors on the back of the cluster.

NOTE: Be careful not to stress the wires or break a connection.

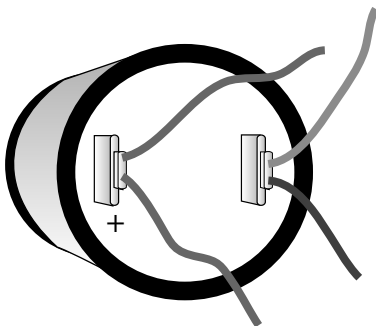

5. Connect New Cluster

Connect new cluster to the using the same connections as the old cluster.

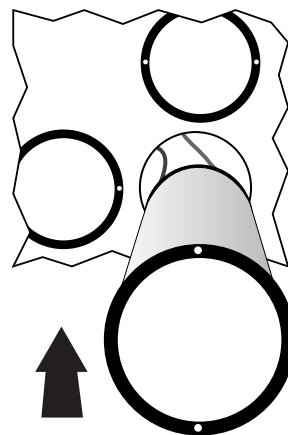

6. Replace Cluster

Slide in new cluster with the holes lined up vertically (12 & 6 O'Clock).

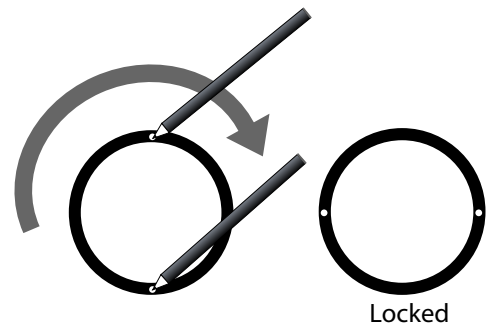

7. Lock Cluster In Place

Turn cluster 1/4 turn using same method as in step 2. Cluster is locked when holes are lined up horizontally (3 & 9 O'Clock). Remove all tools and power up scoreboard to test results.

- (e) Check LED D4 on the receiver board. It should be medium brightness. Change the Dim level on the control console. D4 brightness should change.
- (f) Check if LED D5 on the receiver board is on.

If D5 is on, check if D2 and D6 are flashing and call customer service department. The flash will be very fast. The LED's may appear to be on at half rightness.

If D5 is not on, check that the receiver board is plugged into the power supply and call the customer service department.

(E) The scoreboard works, but some clusters stay on all the time

- (a) With the main power "OFF", switch the plug from the bad digit with the plug for a known good digit.

EXAMPLE: Plug "C" into "D" and "D" into "C" locations.

- (b) Turn the power back on. If the same clusters remain lit all the time, the problem is in the figuregram. If the clusters on a different digit now stay lit all the time, the problem is on the driver PCB assembly. See the replacement parts list for the proper replacement part.

(F) The scoreboard works, but some clusters do not come on.

- (a) Check for burned out clusters.
- (b) Check for a broken wire or bad connection on the 12 pin connector.
- (c) See the replacement parts list for the proper replacement driver board.

5. REPLACEMENT PARTS LIST

5.1 Scoreboard Display Parts

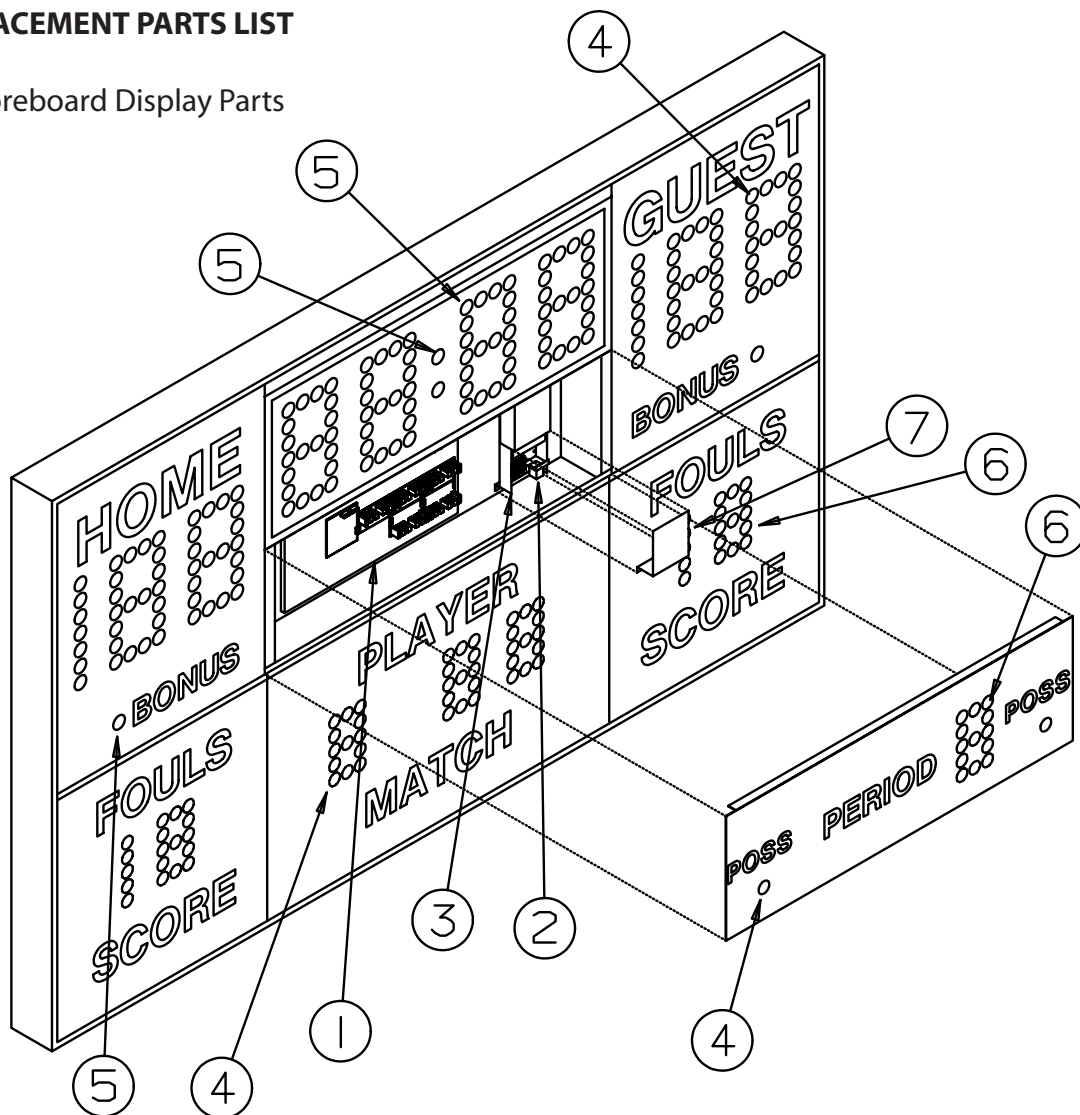

Figure 1 DISPLAY ASSEMBLY

REPLACEMENT PARTS LIST (5214)

Reference #	Part Number	Description
	150704	Display Assembly
1	151032 / 151036(R)	Controller Assembly (See Fig. 2)
2	EL00525P	Relay, 12 VDC DPDT 10A contacts
3	151731	Power Supply Plate (See Fig. 3)
4	150822	Cluster, Green
5	150820	Cluster, Red
6	150821	Cluster, Amber
7	151727	Power Supply Cover
	703609	Horn, 350N
	EL00770P	Radio Antenna (Radio Units Only)

5.2 Controller Assembly Parts

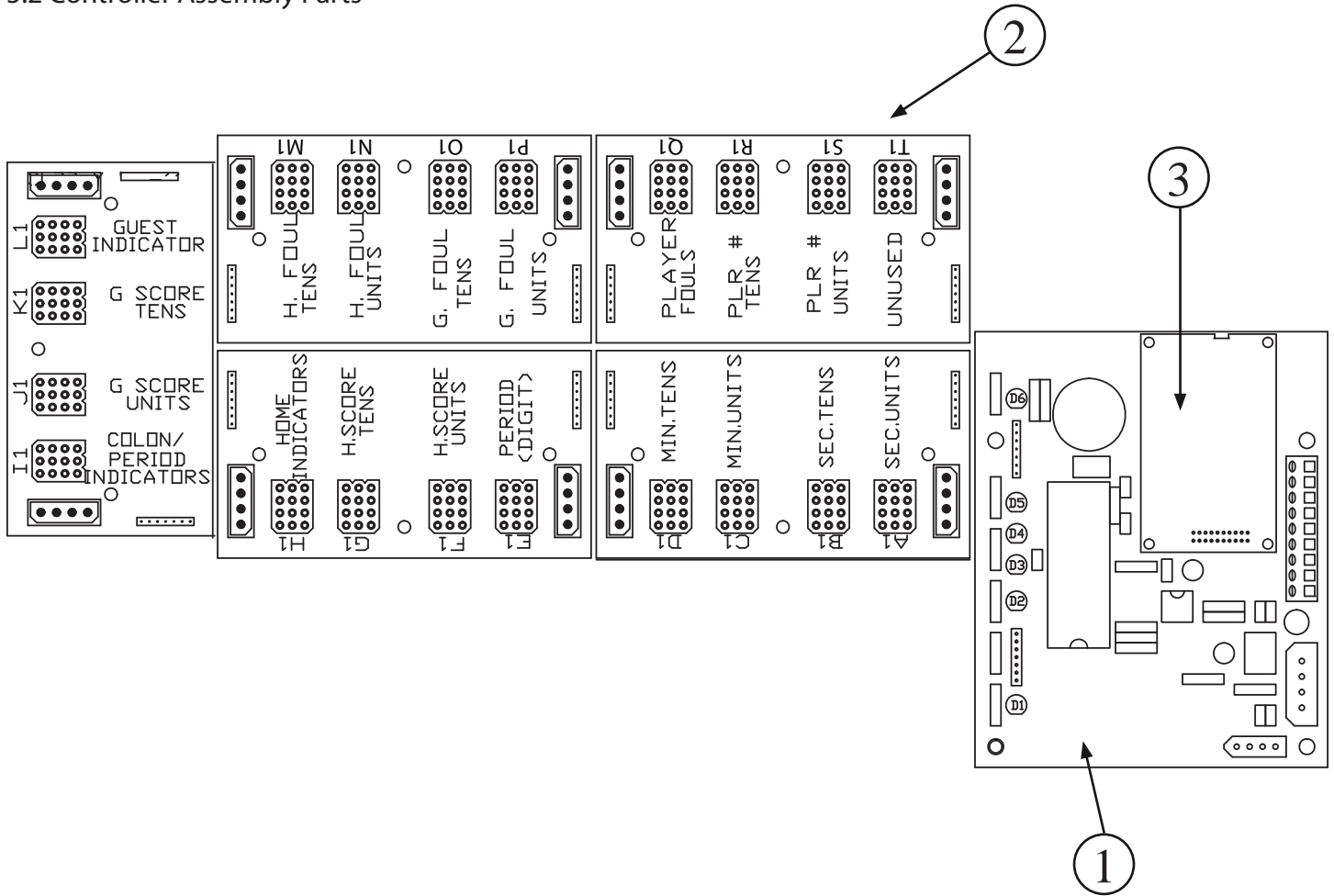

figure 2

CONTROLLER ASSEMBLY

REPLACEMENT PARTS LIST (MP-5214) Controller Assembly

Reference #	Part Number	Description
	151032	Controller Assembly
	151036	Controller Assembly (Radio)
1	EL00863P	Receiver Board
2	EL00862P	Driver Board
3	EL00771P	Radio Transceiver (Radio Only)
	151718	Cable Set, DC Power 4"
	705723	Spacer, Amerlock
	930674	Cable Assembly, 3" Ribbon 7C Fem.

5.3 Power Supply Assembly Parts

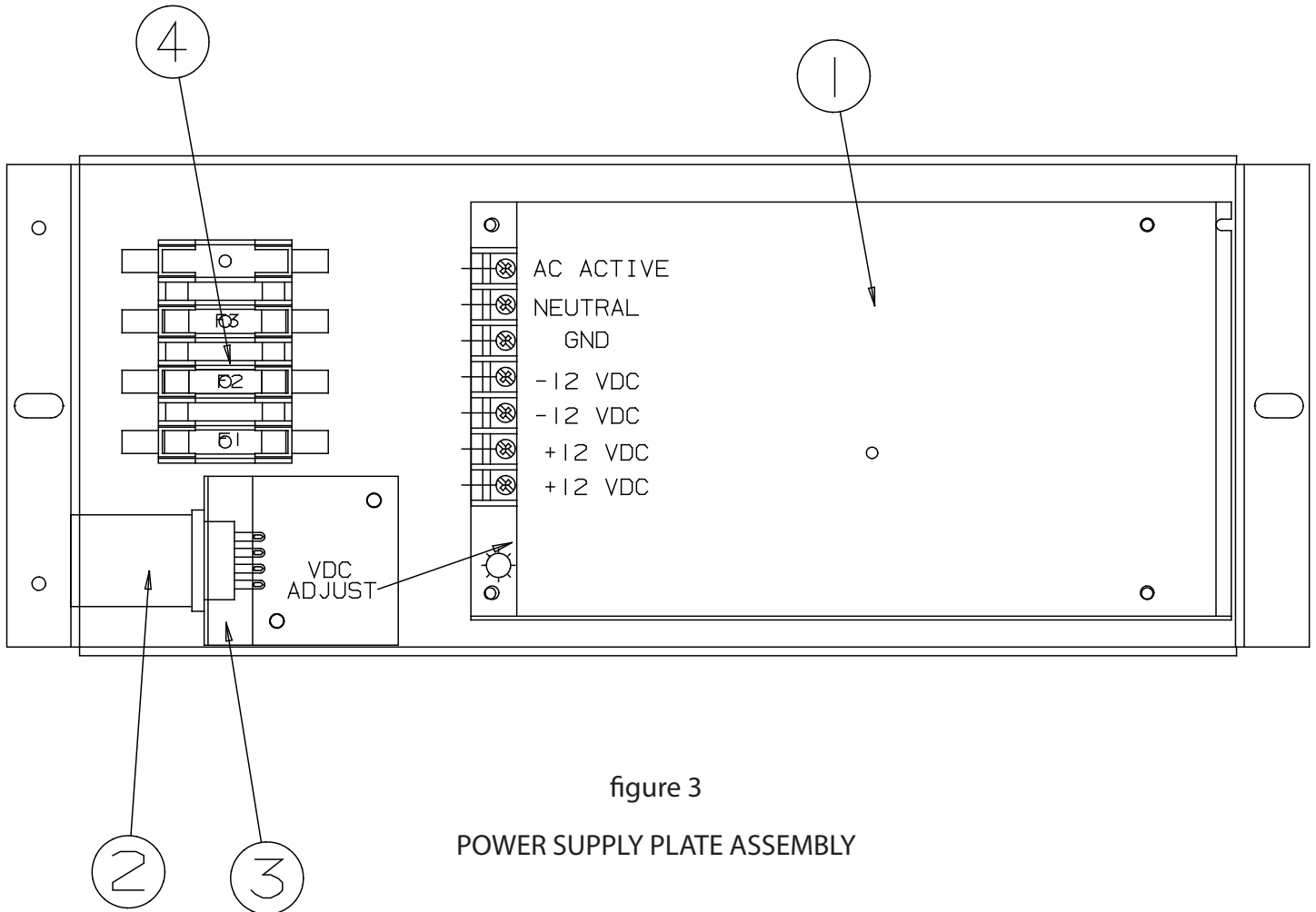

figure 3

POWER SUPPLY PLATE ASSEMBLY

REPLACEMENT PARTS LIST Power Supply Plate Assembly

Reference #	Part Number	Description
	151731	Power Supply Plate Assembly
1	BL00054P	Power Supply, 12V 150 Watt
2	EL00525P	Relay, 12VDC DPDT 10A Contacts
3	703118	Socket, Relay
	701011	Fuse, 5A 250V
	701037	Fuseholder
	151716	Cable Assembly, 3" Power

6. DIAGRAMS

6.1 Keypad Console and Replacement Parts

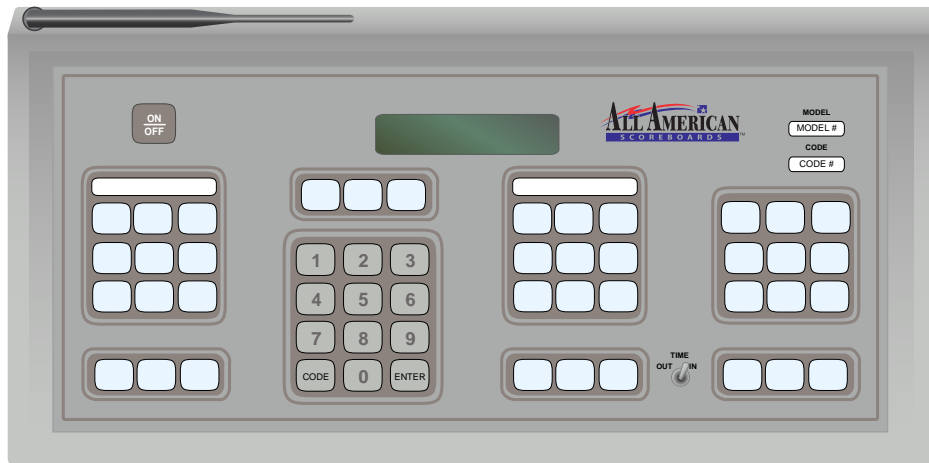

Figure 4

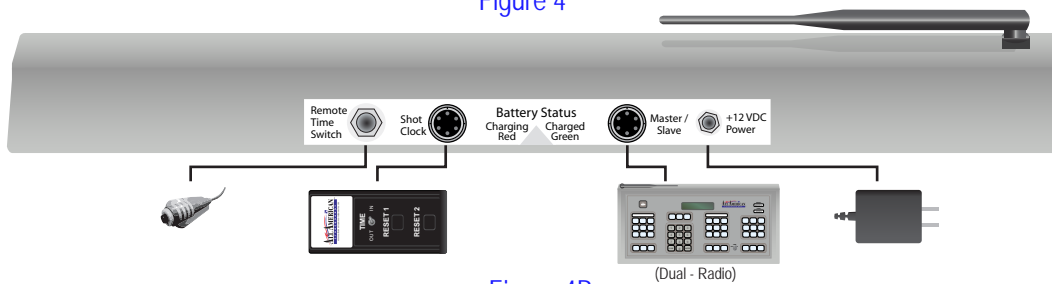

Figure 4B

NOTE: To operate dual signs with a radio unit, a second console must be turned on and connected to the MASTER/SLAVE output via a dual radio console cable (item # 151733). The second console will only be used to transmit information.

Replacement Parts for 5000 Console

Part Number	Description
151735	Controll Console
C5000RB	Controll Console (Radio)
SW005100	Toggle Switch
151740	Cable Assembly, 25'
930894	Connector, 6 Pin Male Cable
EL057700	LCD Display, 2 Line 20 Character
151682	Keyboard Assembly
WH009100	Ribbon Cable Assembly, 14C 8"
MP00468P	Enclosure
MP00705P	Pendant Switch (Remote Time Switch)
EL00769P	Radio Antenna
EL00771P	Radio Transceiver
151739	Wall Junction Box, Single
930895	Connector, 6 Pin Female
150500	Cable, MP-41 Control
151741	Wall Junction Box, Dual

6.2 Scoreboard System Layout

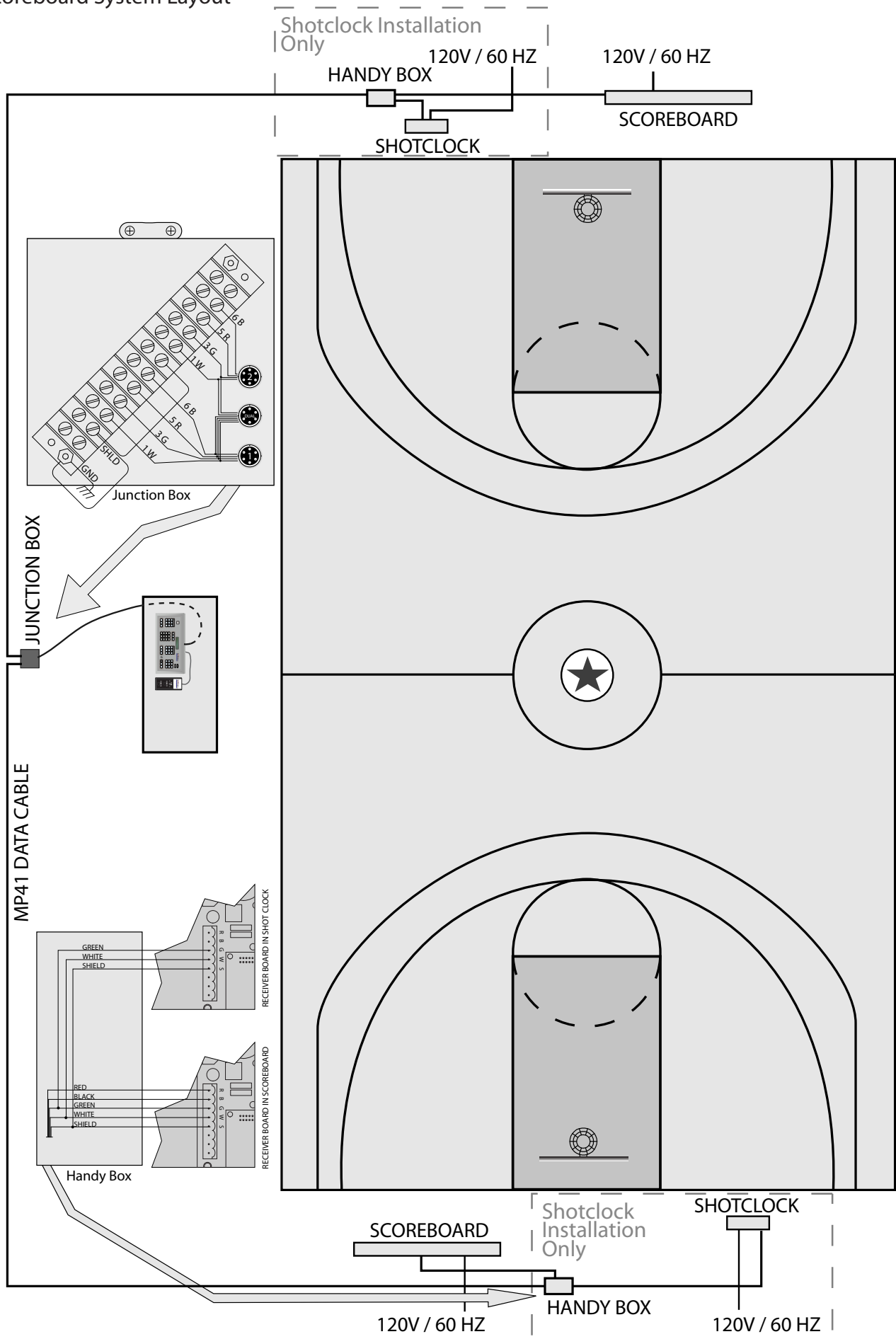

6.3 Single Wall Junction Box Wiring

Single Scoreboard Wiring

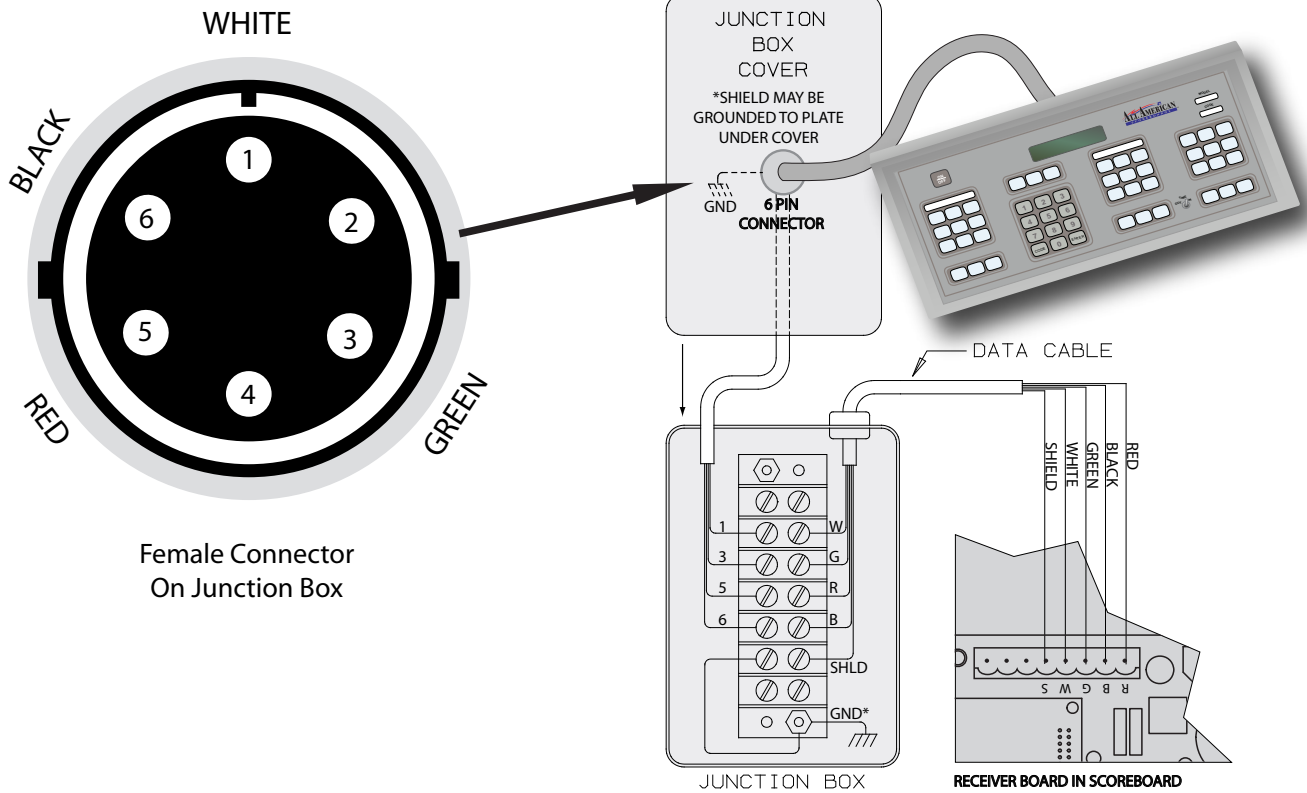

Wiring a Supplemental Display

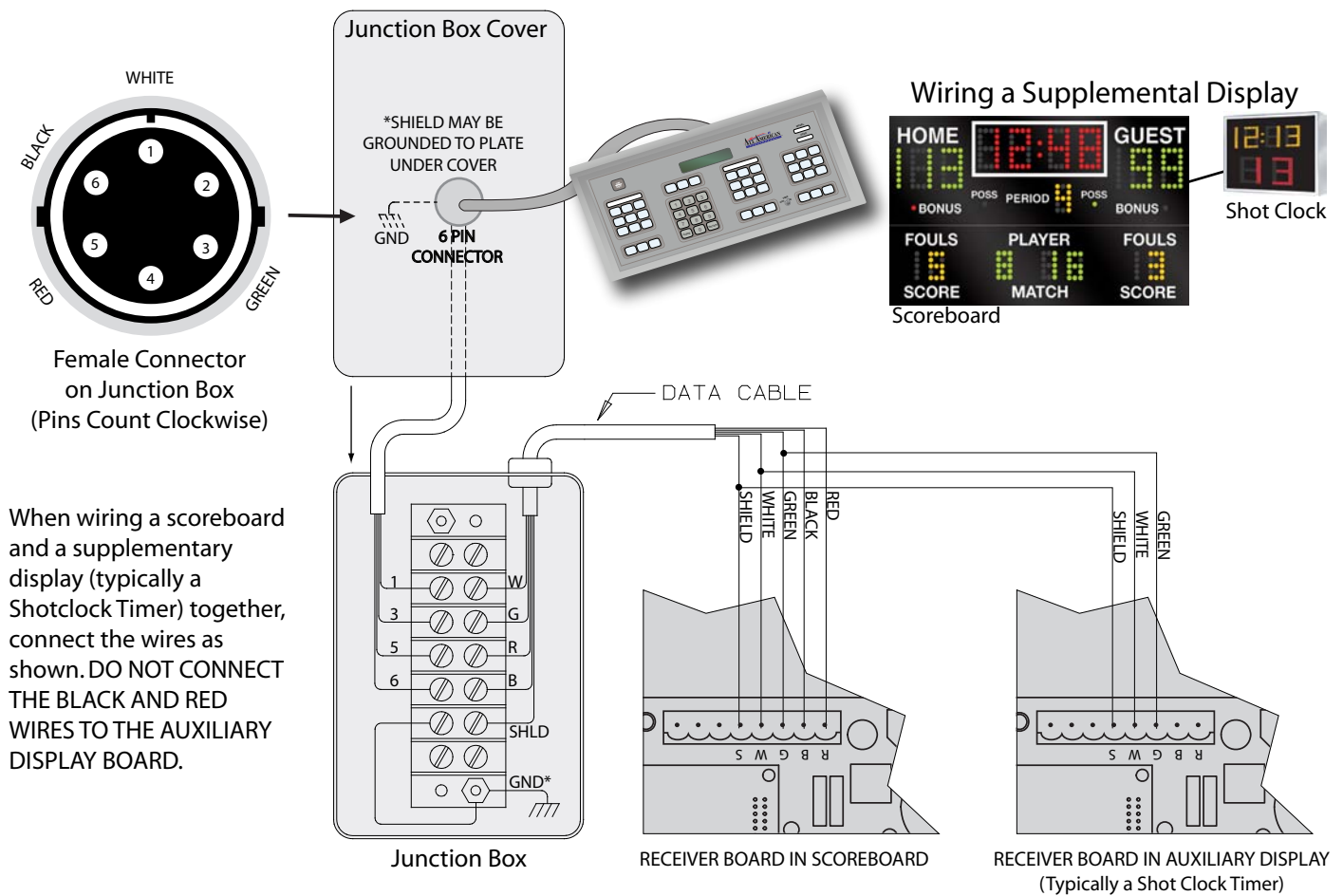

When wiring a scoreboard and a supplementary display (typically a Shotclock Timer) together, connect the wires as shown. DO NOT CONNECT THE BLACK AND RED WIRES TO THE AUXILIARY DISPLAY BOARD.

SINGLE JUNCTION BOX WIRING

6.4 Dual Wall Junction Box Wiring

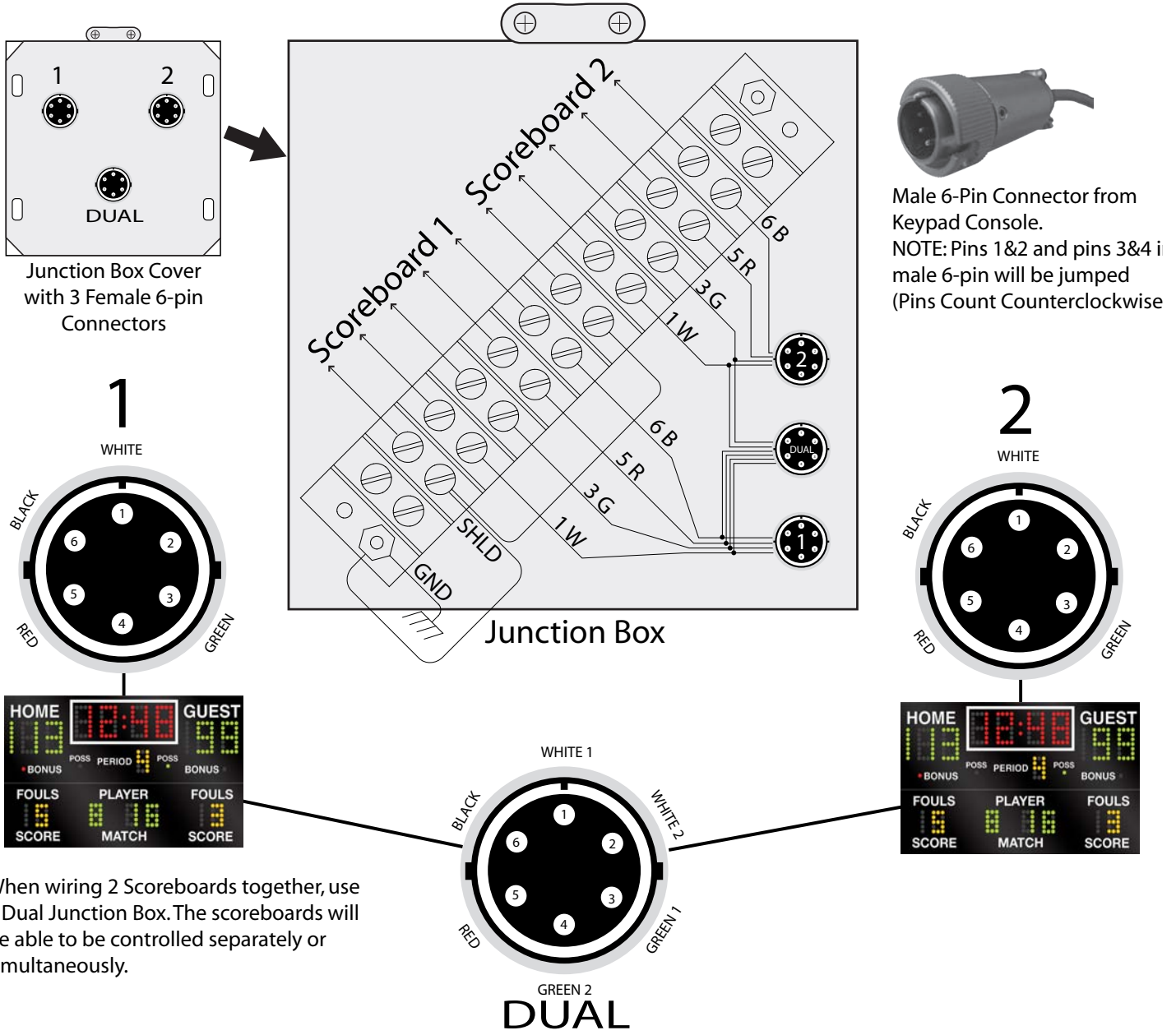

When wiring 2 Scoreboards together, use a Dual Junction Box. The scoreboards will be able to be controlled separately or simultaneously.

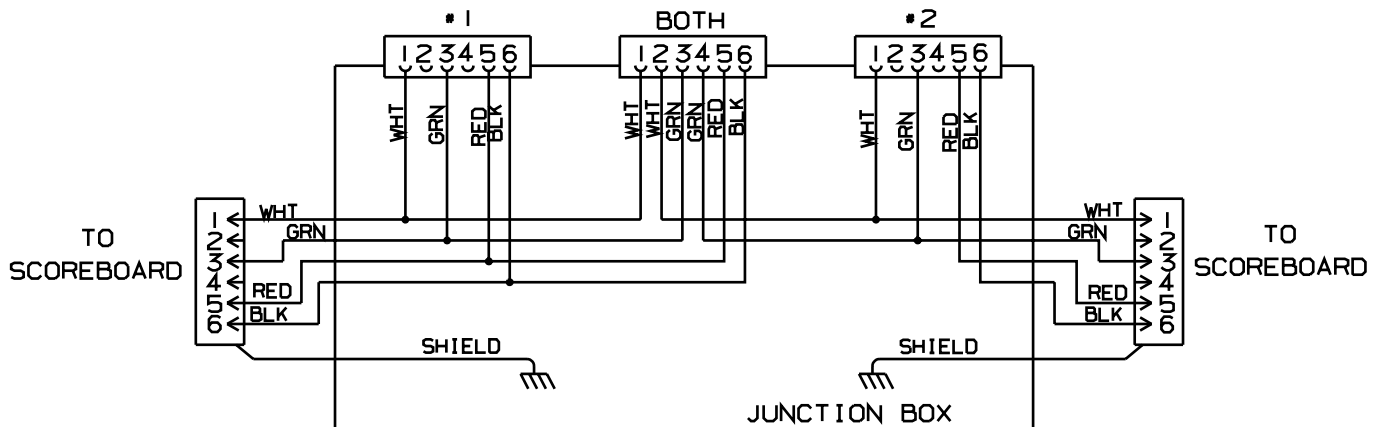

DUAL JUNCTION BOX WIRING

6.5 Controller Wiring Diagram

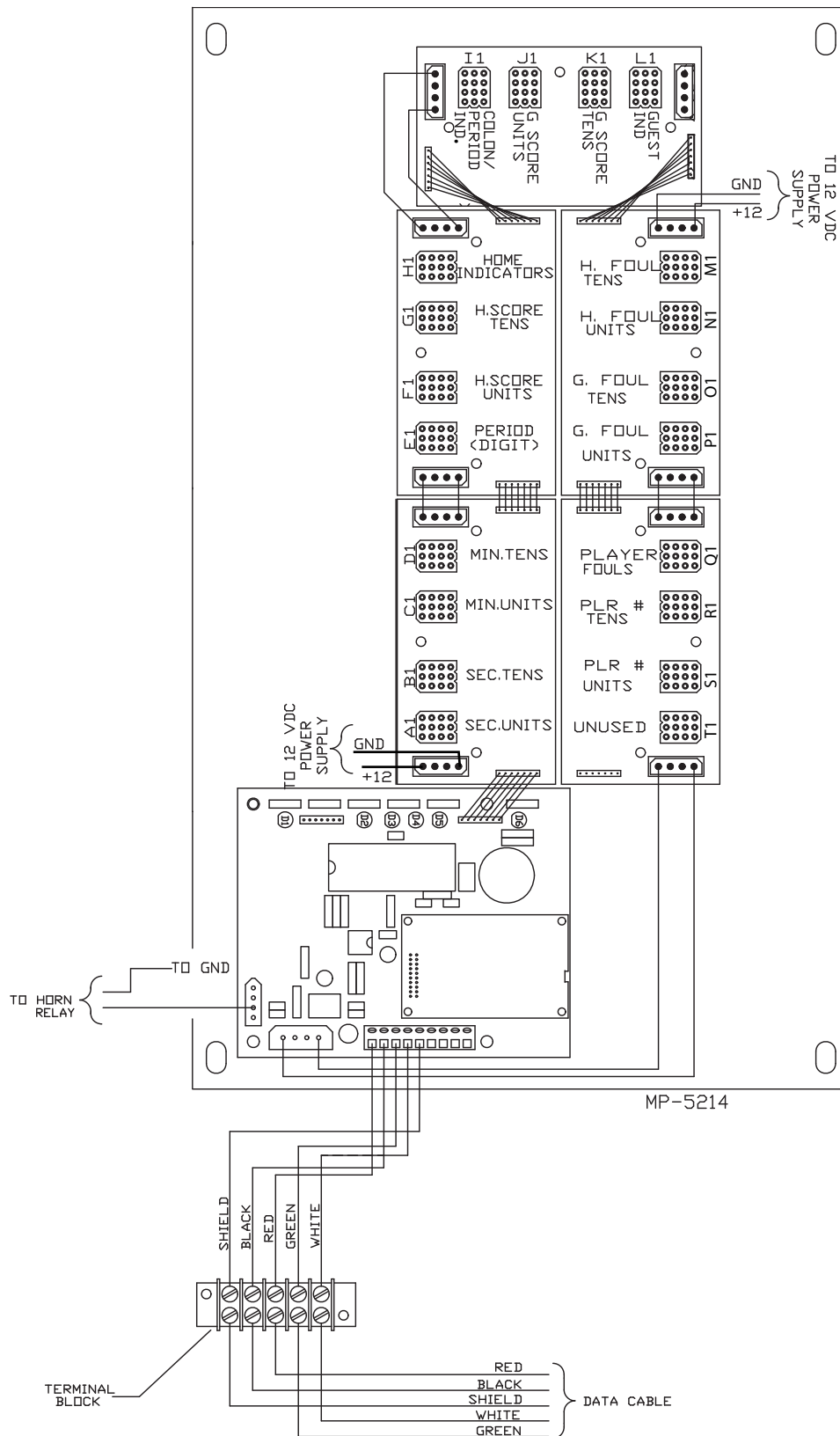

5214 Wiring Diagram

CONTROLLER WIRING

6.6 Power Supply Diagram

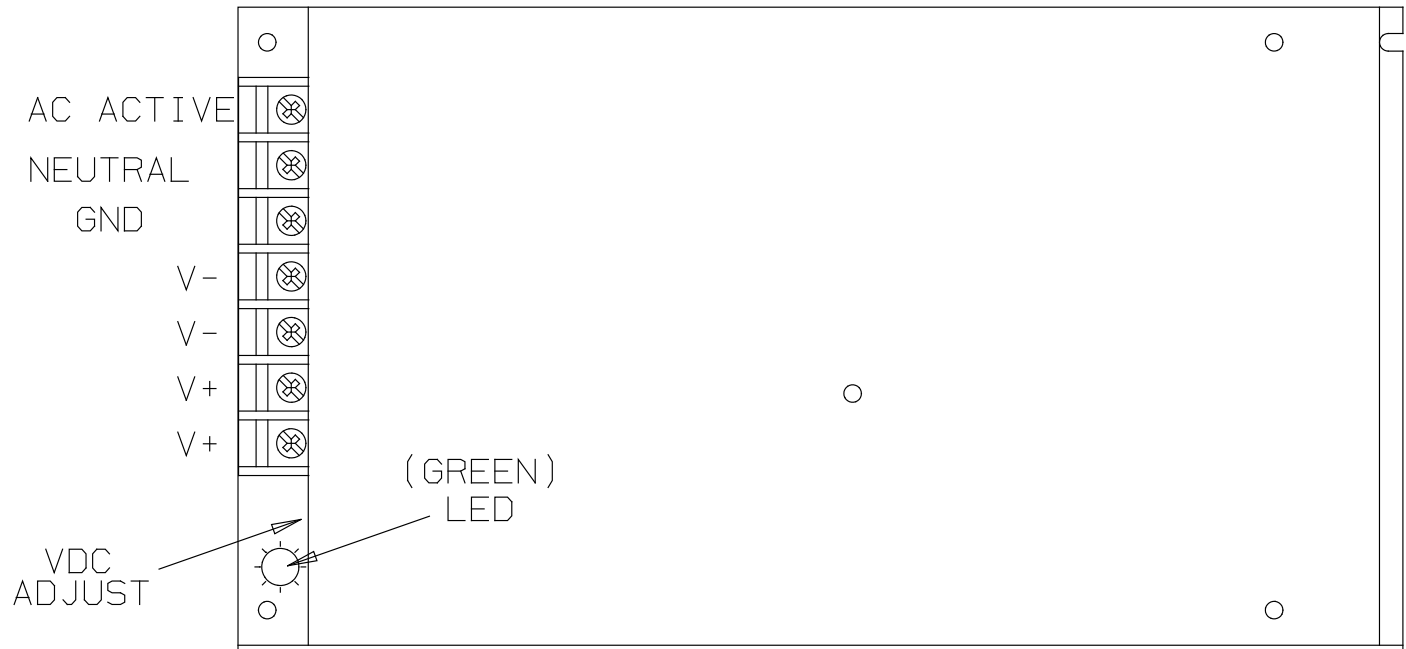

6.7 Receiver Board Diagram

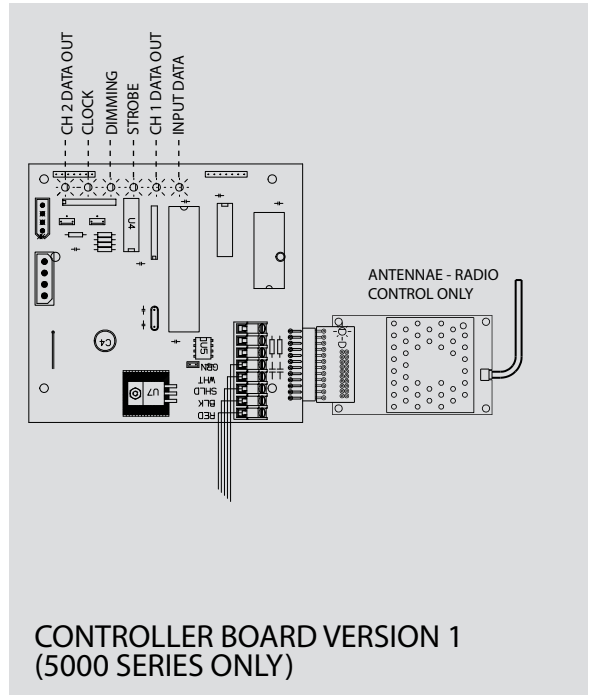
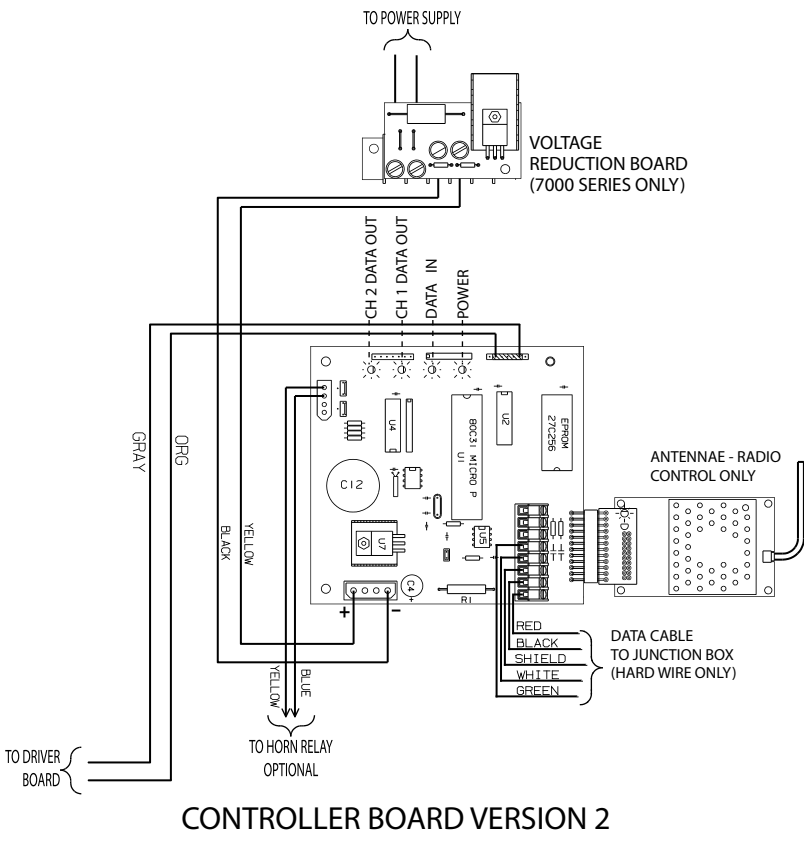
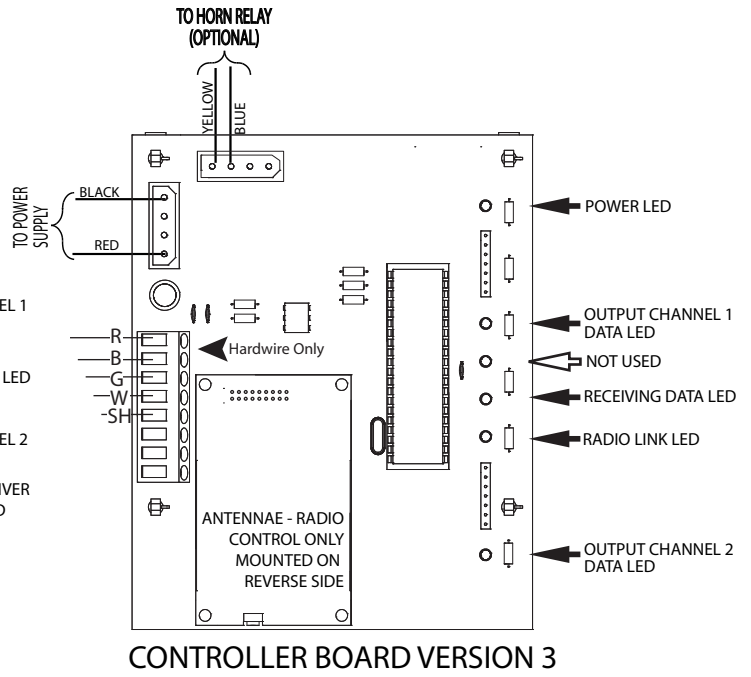
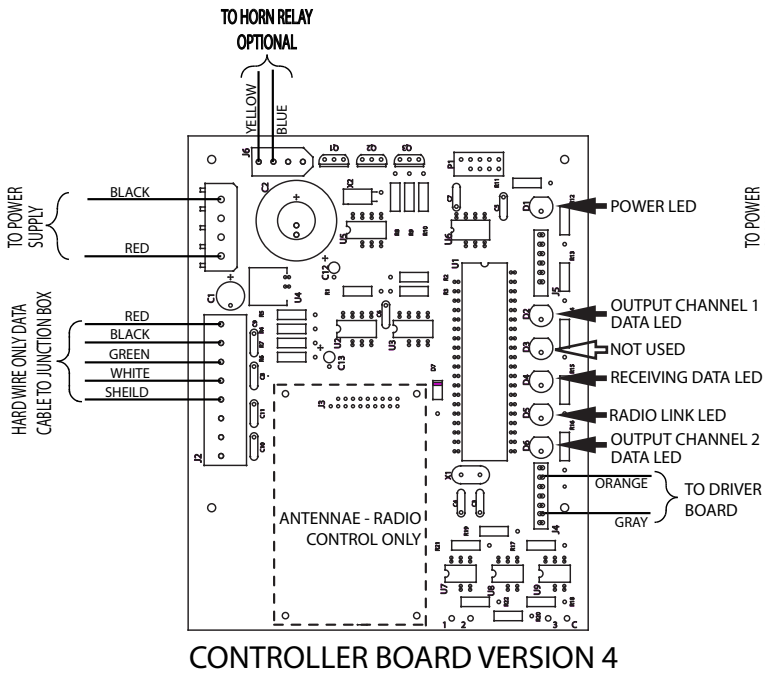

RECEIVER (CONTROLLER) BOARDS

6.8 Driver Board Diagram

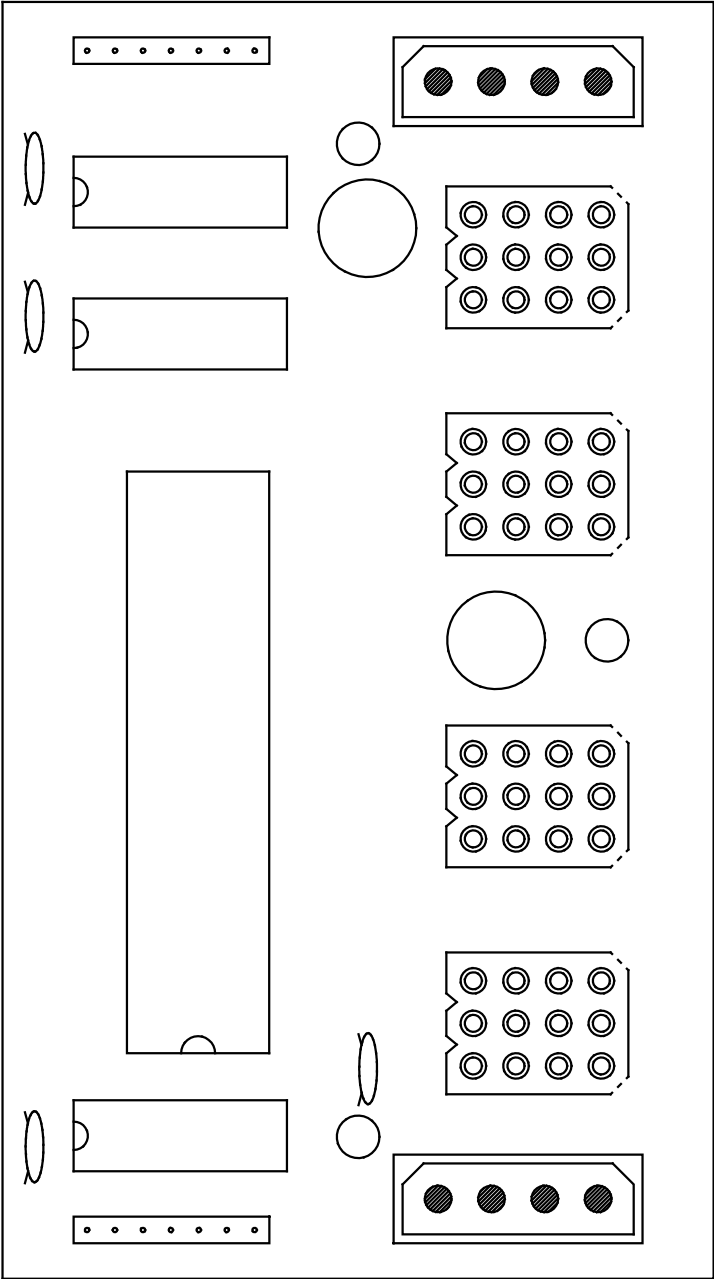

DRIVER BOARD

6.9 Microprocessor 4 X 7 LED Pattern (8 Bit)

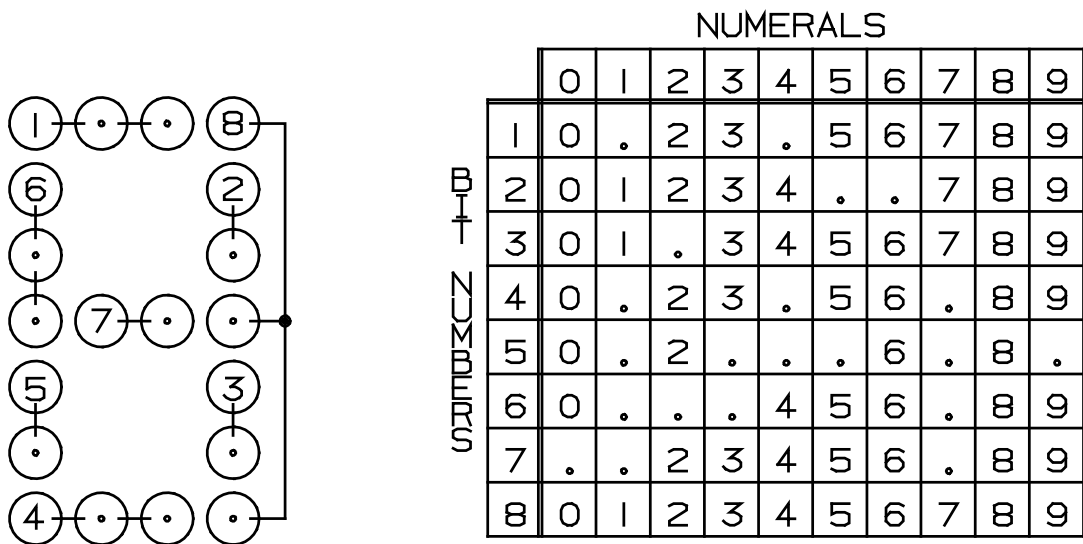
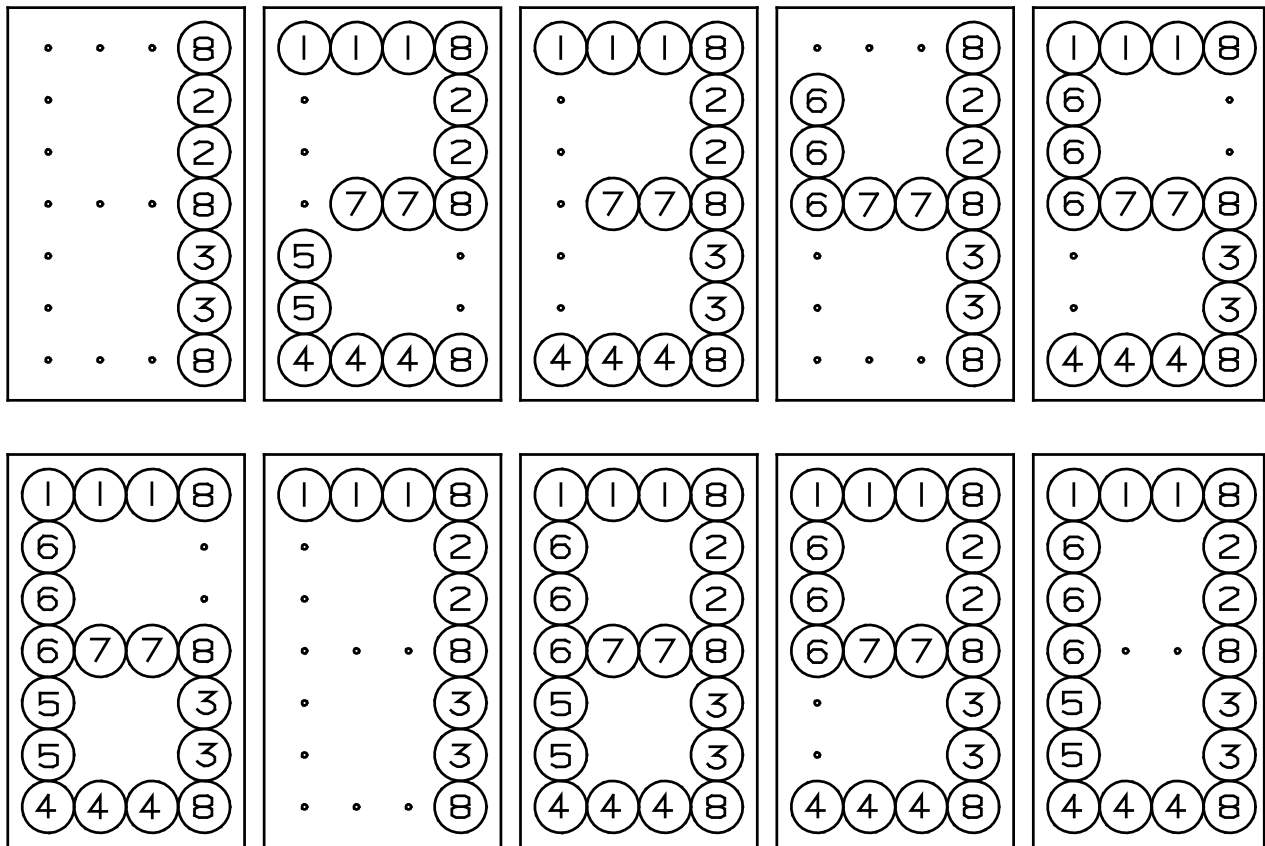

MICROPROCESSOR 4 X 7 (8 BIT) LED PATTERN

6.10 Installation Drawing

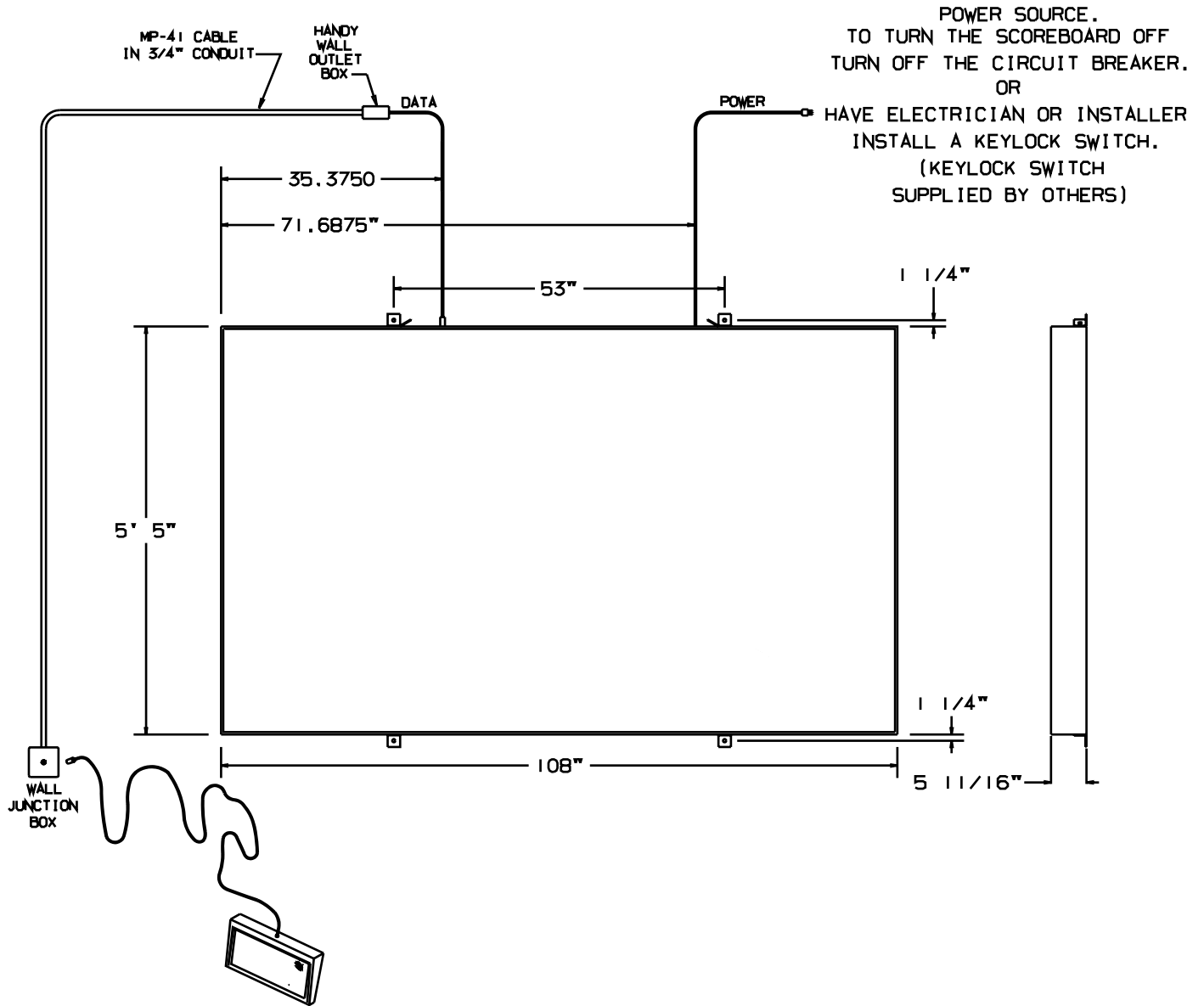

INSTALLATION DRAWING - 5214
(Hardwire shown - Radio units will not have data cable)