



OPERATING INSTRUCTIONS AND SERVICE MANUAL

BASEBALL SCOREBOARD

MODEL MP-3814 WITH MP-3000 CONTROL

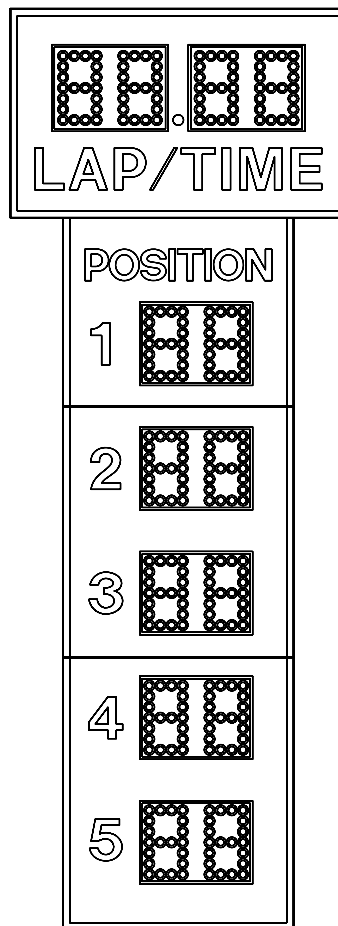

TABLE OF CONTENTS

1. GENERAL INFORMATION
 - 1.1 DESCRIPTION
 - 1.2 IDENTIFICATION
 - 1.3 DAMAGE
 - 1.4 DAMAGE CLAIM PROCEDURE
2. INSTALLATION
 - 2.1 GENERAL INFORMATION
 - 2.2 INSPECTION
 - 2.3 DATA CABLE INSTALLATION
 - 2.4 ELECTRICAL CONNECTIONS
3. CONTROL CONSOLE OPERATION
 - 3.1 CONSOLE DISPLAY
 - 3.2 CONSOLE POWER
 - 3.3 TIME TRIALS
 - 3.4 RACE MODE
 - 3.5 DIMMER
4. MAINTENANCE AND TROUBLESHOOTING
 - 4.1 INTRODUCTION
 - 4.2 TEST EQUIPMENT
 - 4.3 TROUBLESHOOTING
 - 4.4 TROUBLESHOOTING GUIDE
5. REPLACEMENT PARTS LIST
 - 5.1 SCOREBOARD DISPLAY PARTS
 - 5.2 SCOREBOARD CONTROLLER ASSEMBLY PARTS
6. DIAGRAMS
 - 6.1 CONTROL CONSOLE KEYBOARD AND SLIPSHEET LAYOUT
 - 6.2 SCOREBOARD SYSTEM LAYOUT
 - 6.3 JUNCTION BOX WIRING DIAGRAM
 - 6.4 POWER WIRING DIAGRAM (D-7828)
 - 6.5 CONTROLLER PLATE WIRING AND LAYOUT (D-7829)
 - 6.6 MICROPROCESSOR 4 X 7 LAMP PATTERN (8 BIT)
 - 6.7 FIGUREGRAM WIRING DIAGRAM (C-150429)
 - 6.8 JUMPER LOCATION ON 3 POSITION SYSTEM
 - 6.9 TRIAC PLACEMENT DIAGRAM
 - 6.10 INSTALLATION DRAWING (C-7816)

1. GENERAL INFORMATION

1.1 DESCRIPTION

Your All-American scoreboard has been carefully inspected and tested before leaving the factory. It is possible, however, that components may be loosened or forced out of adjustment in transit. If this occurs, follow the troubleshooting guide (section 4). If equipment then fails to operate, contact immediately:

ALL-AMERICAN Service Department
EVERBRITE LLC
P.O. Box 100
Pardeeville, WI 53954
Telephone: (608) 429-2121
Toll Free: 800-356-8146
E-mail: score@everbrite.com

Parts being returned for repair are to be sent to:

ALL-AMERICAN Service Department
EVERBRITE LLC
401 S. Main Street
Pardeeville, WI 53954

NOTE

If you need to send parts in for repair, please call the ALL AMERICAN service department for a returned goods authorization (RGA) number.

1.2 Identification

ALL-AMERICAN uses a 4 digit serial number for scoreboard identification. The serial number tags are located on the back of the control console and the lower right hand corner on the face of the scoreboard display. When contacting the factory for assistance it is important that the model number and serial number are known.

1.3 Damage

Upon receipt of equipment, check for visible damage. If this occurs, or if damage is found after shipment has been accepted, follow the damage claim procedure.

1.4 Damage Claim Procedure

An instruction sheet is enclosed advising the consignee in case of damage in transit. If damage is noted at the time of delivery, consignee must obtain an 'Inspection of Bad Order' from the delivering carrier. In order to process your claim, this must be properly filled out with a complete statement of all damage and it must be signed by the carrier.

If damage is discovered after delivery, you should call the delivery company. Have them make out a Concealed Damage Report. Fifteen days after delivery are allowed, so this should be done promptly or it is impossible to process this claim.

Advise EVERBRITE corporation of necessary replacement parts, or repairs. Consignee will be invoiced and then should file a claim with the carrier to recover charges. To file your claim follow this procedure:

- (A) Cost of replacement parts or repair charges are invoiced to the carrier by the consignee.
- (B) The following documents, properly filled out, plus invoice, are forwarded to the trucking company in support of your claim:

- (a) Original bill of lading
- (b) Original paid freight bill
- (c) Certified copy of original invoice
- (d) Standard form for presentation of loss and damage claim

2. INSTALLATION

2.1 General Information

Shipping papers accompany each scoreboard. Check carefully to see that you receive the following:

- 1 ea RACETRACK Display (4 SECTIONS)
- 1 ea Control Console
- 1 ea Service Manual
- 1 ea Mounting Hardware Package
- 1 ea Press Box Junction Box
- ? ft Control Cable (if ordered)
- 1 ea Electric Eyes (if ordered)

IMPORTANT!

The MP-40 cable supplied by ALL AMERICAN SCOREBOARDS for use on the Microprocessor based scoreboards is specifically designed for this system. Use of a substitute cable may void the warranty on the scoreboard!

NOTE

A small length of rubber hose may be used as a lamp extractor. Simply taper the inside of the hose with a sharp knife to fit the lamp.

2.2 Inspection

Inspect each unit and tighten all screws, lamps, and fittings that may have loosened in shipment.

2.3 Installation

Select the location best suited for visibility by the majority of spectators. Preferred position is facing east or north to avoid direct sunlight on the face of the scoreboard, if day games are played.

The MP-41 data cable carries only low voltage signals and therefore can be installed with or without conduit. consult section 6 for junction box and scoreboard wiring.

2.4 Electrical connections

This scoreboard requires two 120 V. 30 AMP AC circuits for the exclusive use of the scoreboard.

NOTE !

To protect the MP-3000 control from damage, it is advisable that you disconnect the control and store in a dry secure area when not in use.

NOTE

This equipment is **ETL** (Electronics Testing Laboratories) **CSA** and **NRTL** approved and complies with the requirements in part 15 of the FCC rules for a class A computing device. Operation of this equipment in a residential area may cause unacceptable interference to radio and television reception, requiring the operator to take whatever steps are necessary to correct the interference.

3. CONTROL CONSOLE OPERATION

3.1 Console Display

The 2 line by 20 character Liquid Crystal Display module displays the scoreboard information entered from the keyboard.

3.2 Console Power

Plug the control console cable into the junction box connector marked "**DATA**".

Plug the electric eye cable into the junction box connector marked "**EE**".

Push **ON/OFF** once to turn the console on.

Push **ON/OFF** a second time to turn the console off.

When first turned on; the LCD should show as follows:

**RACETRACK
1992 VERSION 2.1**

Enter the code (88) as follows: Push **CODE** **8** **8** **ENTER** .

When the proper code has been entered, the scoreboard will be in the race mode and the LCD will show as follows:

**TOP 5
LAP 0**

3.3 Time Trials

Push **TIME/RACE** to enter the time trial mode. The scoreboard time will show **.00**

and the LCD display will show

**.000 --.--- --.--- .
1 LAP TRIAL**

Select the laps to be time trialed by pushing **1 LAP** , **2 LAP** , or **3 LAP** .

The LCD display will reflect your selection.

Push **EE ENABLE** to enable the electric eye.

When the EE is enabled the LCD display will show EE in the lower left corner.

If, for example, car number 55 is going to time trial; Push **POS 1** , and the car number **5** **5** , and then **ENTER** .

Car number 55 would appear on the scoreboard in position 1, and you would be ready for time trials.

When the EE beam is broken the time will start. The 1/100th digit is blanked while the timer is running.

Push **EE ENABLE** at any time to disable the electric eye.

When the EE beam is broken a second time, the time will stop and the hundredths digit will display on the scoreboard and LCD display.

If you are timing 2 or 3 laps at a time, when the car breaks the EE beam the second time, the time displayed on the scoreboard will stop for two seconds and then resume timing the second

lap. The LCD on the control console will show the time for the first lap in position 1 and the elapsed time for the second lap in position 2.

After the time trial you may post the lap times as follows: Push **TIME RESET** to reset the times to zero. The scoreboard will now read .00 , and the times on the LCD display will all revert to zeroes.

Now push **1** **8** **4** **3** , then **ENTER** and the time 18.43 will post on the scoreboard.

If a car starts to time trial but doesn't finish the lap, you may record the times for any completed laps, then push **TIME RESET** to reset the scoreboard and LCD displays.

You may now post the lap time of the completed lap and you are now ready for the next car to time trial.

3.4 Race Mode

The LCD shows the car positions for five (5) cars and the Lap number at all times.

Push **LAP +1** to increment the lap counter.

Push **LAP -1** to decrement the lap counter.

Push **LAP** followed by the desired number(s), then **ENTER** to correct the Lap counter.

Push **POS 1** followed by the Car #, then **ENTER** to load the 1st Place Car #.

Repeat the procedure for **POS 2** through **POS 5** .

Push **LAP** or **POS 1** through **POS 5** then **CLEAR** to clear the respective locations.

3.5 Dimmer

Push **DIM** to dim the lamps during night use.

WARNING

120 VAC wires are exposed whenever the cover over the controller assembly is removed from the scoreboard. Use extreme caution during troubleshooting or repair. To avoid possible damage to equipment or personal injury, always turn off the main power before removing the cover or replacing assemblies, or replacing lamps.

4. MAINTENANCE AND TROUBLESHOOTING

4.1 Introduction

This section gives maintenance and troubleshooting information. Included are troubleshooting guides for typical scoreboard malfunctions. If the cause of a problem cannot be determined, please contact the customer service department.

4.2 Test Equipment

A simple analog or digital voltmeter will be sufficient for all user repairable problems. Printed circuit boards requiring troubleshooting should be returned to the factory.

4.3 Troubleshooting

Whenever possible; follow the troubleshooting guides, prior to contacting the customer service department. If a problem not described in the guides exists, contact the customer service department immediately. Refer to the diagrams provided for assistance in troubleshooting scoreboard malfunctions.

4.4 Troubleshooting Guides

(A) Scoreboard doesn't light and console doesn't work

- (a) Check that the main power switch is turned on.
- (b) Replace any defective or blown fuses.
- (c) Check the power connections and voltages at the scoreboard.
- (d) Contact the customer service department.

(B) Scoreboard digits don't light, but the console works

- (a) With the main power switch "off"; remove the cover over the controller assembly.
- (b) Check all connections.
- (c) Turn the main power on.
- (d) If the scoreboard still doesn't light, check the transformer voltage going to the receiver PCB (printed circuit board) assembly (blue wires) using a voltmeter set on the 12 VAC or higher scale.

If the voltage is less than 8 VAC contact the customer service department.

If the voltage is between 8-12 VAC see the replacement parts list for a receiver PCB assembly, and contact the customer service department.

(C) The scoreboard digits light but the console doesn't work

- (a) Check for continuity between the scoreboard and the junction box.
- (b) If an open circuit is found, the problem is either the cable or a cable connection.
- (c) If the continuity test checks good, check the voltage between the green wire and the white wire in the junction box, using a voltmeter set on the 12 VAC or higher scale.

If the voltage is 0 VAC, see the controller parts list, for a transformer assembly.

If the voltage is less than 8 VAC, consult the controller wiring diagram for instructions on long cable compensation.

If the voltage is between 8 VAC and 12 VAC, contact the customer service department.

- (D) The scoreboard digits light, the console works, but there is no control of the scoreboard.
- (a) Check the voltage between the black and red wires in the junction box with a voltmeter set on the 3 VDC or higher scale. The voltage should read somewhere between 2-3 VDC when the console is working properly.
 - (b) If the voltage is 0 VDC contact the customer service department for assistance.
 - (c) If the voltage is correct, (2-3 VDC) check that this reading also appears at the scoreboard.
 - (d) If the correct voltage also appears at the scoreboard, see the replacement parts list for a receiver PCB assembly.

IMPORTANT !!!

In this scoreboard the 120 volt line is on the lamp socket all the time, and the common is switched to turn the lamps on and off. For this reason, to avoid damage to the equipment or personal injury, it is important to turn the main power off when changing the lamps.

- (E) The scoreboard works, but some lights stay on all the time
- (a) With the main power "OFF", switch the plug from the bad digit with the plug for a known good digit.

EXAMPLE: Plug "C" into "D" and "D" into "C" locations.
 - (b) Turn the power back on. If the same lamps remain lit all the time, the problem is a shorted lamp socket. If the lamps on a different digit now stay lit all the time, the problem is on the driver PCB assembly. See the replacement parts list for the proper replacement part.
- (F) The scoreboard works, but some lights do not come on.
- (a) Check for burned out lamps.
 - (b) Check for a broken wire or bad connection on the 12 pin connector.
 - (c) See the replacement parts list for the proper replacement driver board.

5. REPLACEMENT PARTS LIST

5.1 Scoreboard Display Parts

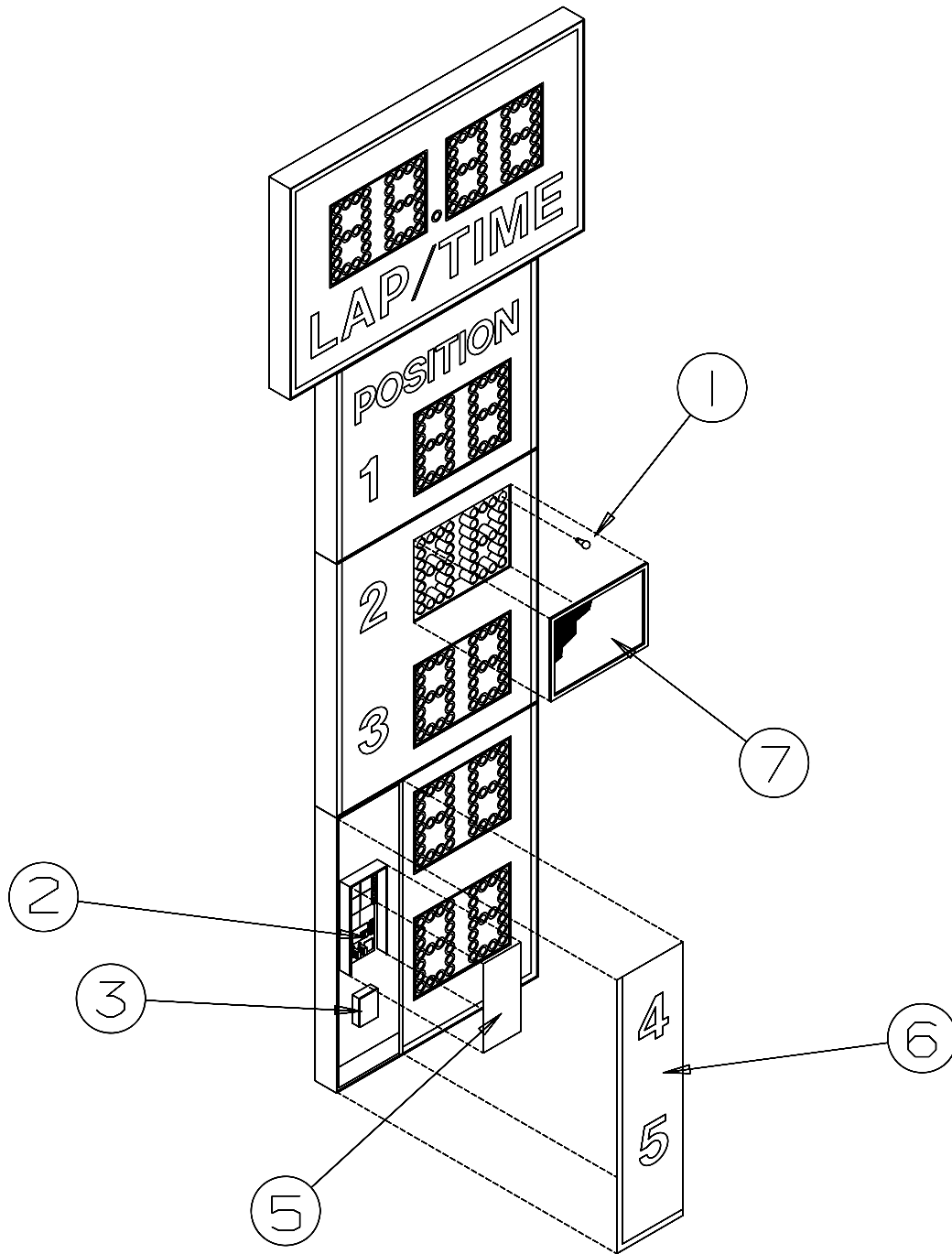

figure 1

DISPLAY ASSEMBLY

REPLACEMENT PARTS LIST (MP-3814 Racetrack)

fig.& index	MFG PART NUMBER	DESCRIPTION	REF DES	VENDOR PART #
1- 1-1	000000 850030	Display Assembly Lamp, 25W/125V Clear		000000 25A19 GR CL
1-2	000000	Controller Assembly *****SEE FIGURE 2*****		000000
1-3 1-4	EL044100 121880	Resistor, 2 OHM 30 WATT Fuse, 15A. 250V.	F1-F2	HL-24-09Z ABC-15 (3AG)
	SU4450 HB005500 HB002300 SW005100 702785 702786 EL053000 HB002400 WH009100 122763	Control Console Slipsheet Pair Transmitter PCB Assembly Toggle Switch, Connector, 5 Pin Male Cable Connector, 5 Pin Female LCD Display, 2 Line 20 Character Keyboard Assembly, Ribbon Cable Assembly, 14C 8" Enclosure,	A1 S1 P1 J3	SU4450 HB005500 HB002300 SW005100 RM12BPG5P RM12BRD5S HB002400 WH009100
	151204 702786 150500 000000	Junction Box, Single Connector, 5 Pin Female Cable, MP-41 Control Terminal Strip, 7C	J1/J4	151204 RM12BRD5S 8723 670-7
	000000	Cable Assembly, 20' W/2 Male 5C Con.		000000

5.2 Scoreboard Controller Assembly Parts

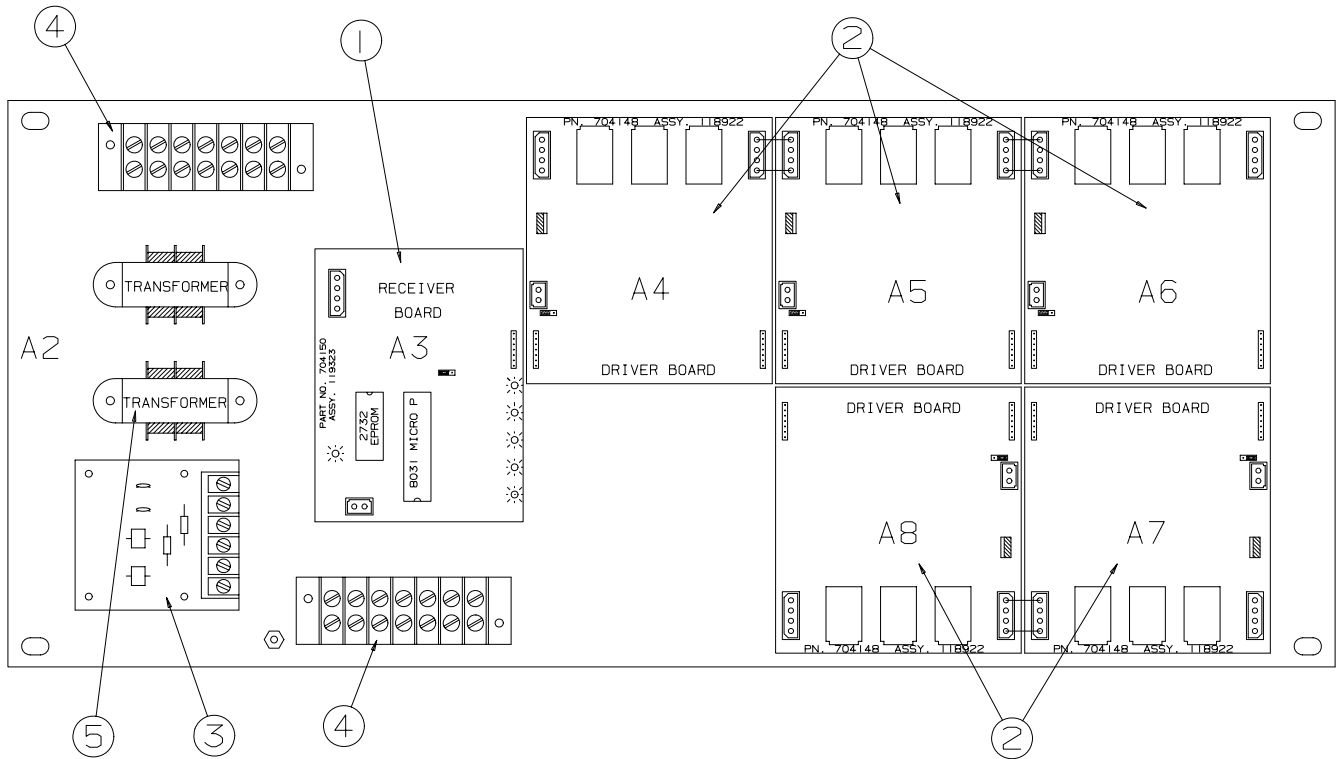

REPLACEMENT PARTS LIST (MP-3814 Controller Assembly)

fig. & index	MFG PART NUMBER	DESCRIPTION	REF DES	VENDOR PART #
2-	SU479400	Controller Assembly	A2	SU479400
2-1	119323	Receiver PCB Assembly *** PROGRAM CNTVER.105***	A3	119323
2-2	118922	Driver PCB Assembly, 3 Position	A4-A8	118922
2-3	118522	Transient Suppressor PCB Assembly	A12	118522
2-4	701137	Terminal Block, 7C	TB1&2	670-7
2-5	703719	Transformer, 8V/18V	T1/T2	CS-697
2-6	HB005600	Cover		HB005600
2-7	705723	Spacer, P.C. Board		LCBS-6-01

6. DIAGRAMS

6.1 Control Console Keyboard and Slipsheet Layout

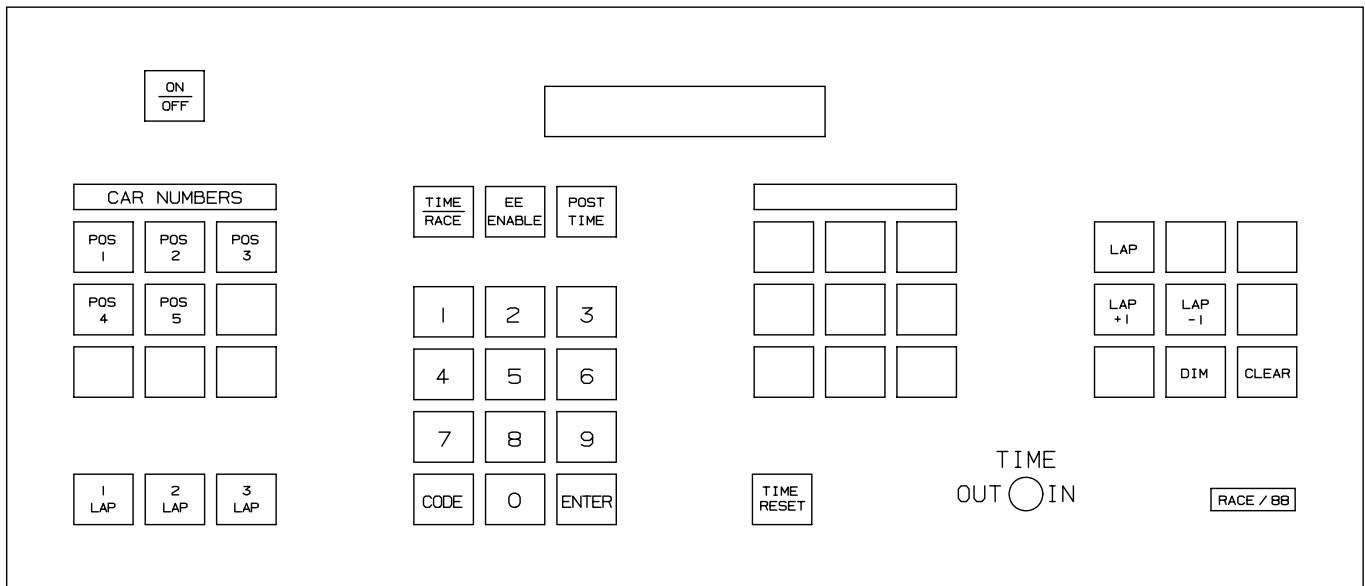

CONSOLE KEYBOARD

6.2 Scoreboard System Layout

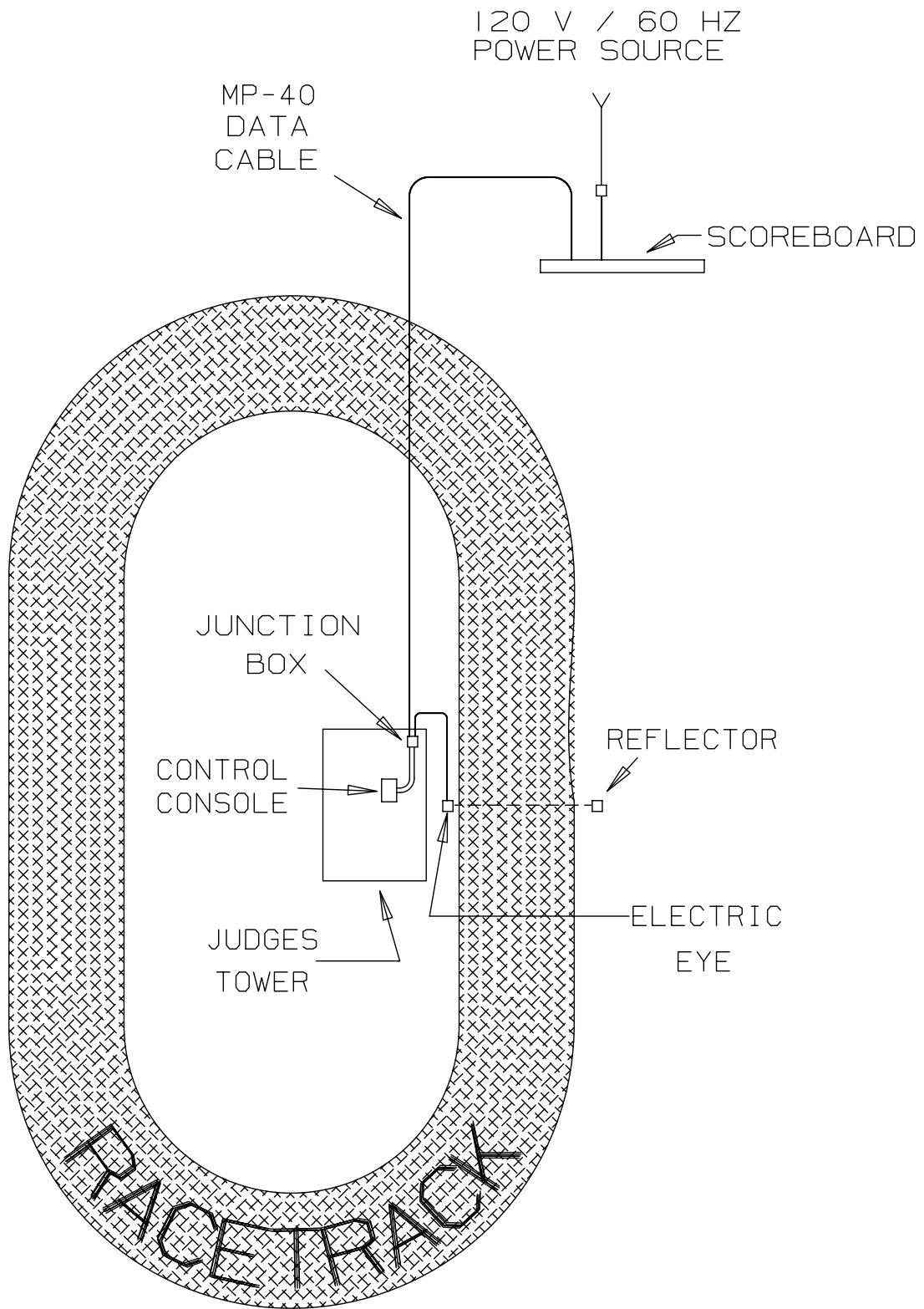

SYSTEM LAYOUT

6.3 Junction Box Wiring

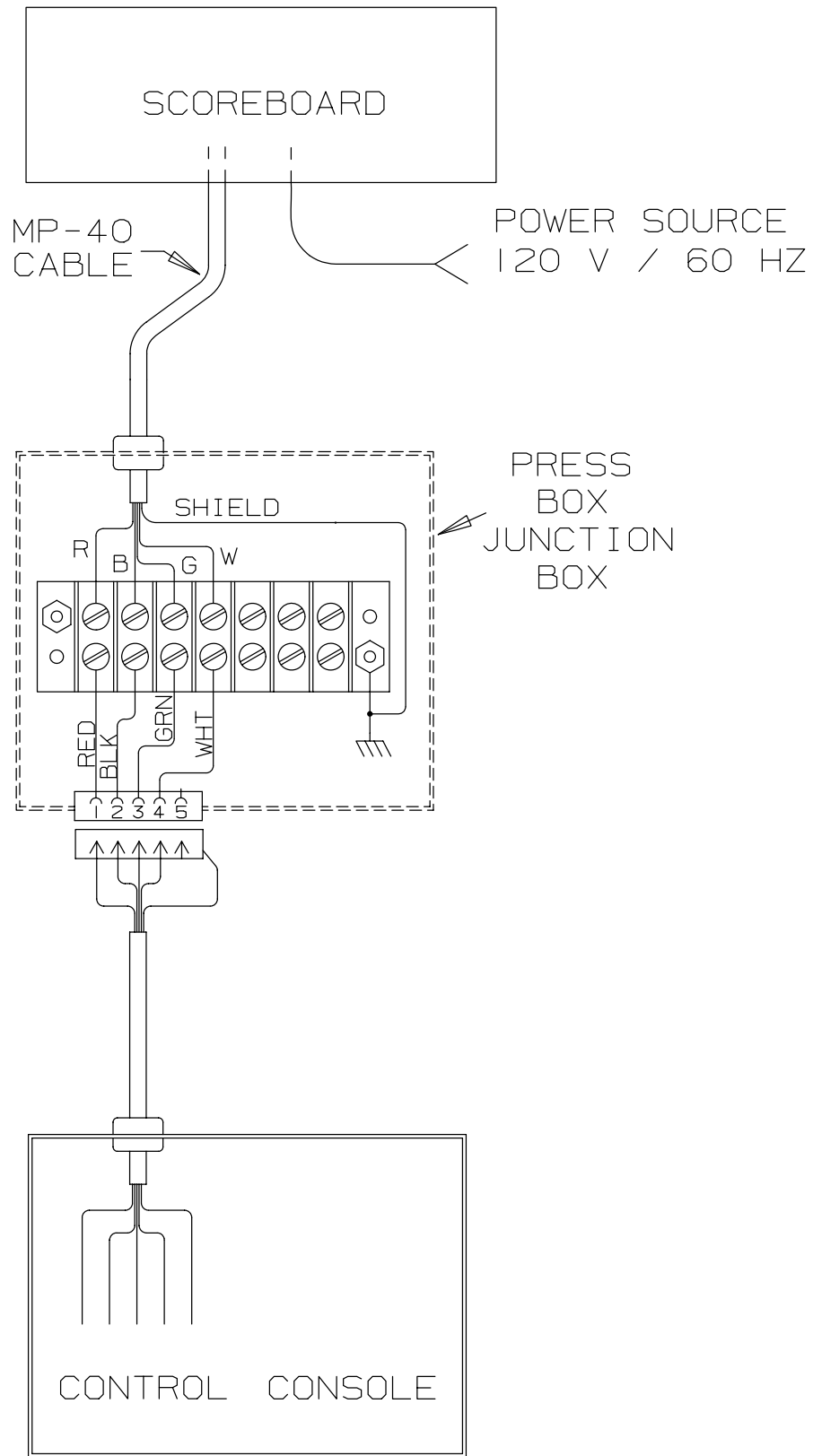

SINGLE JUNCTION BOX WIRING

6.4 Power Wiring

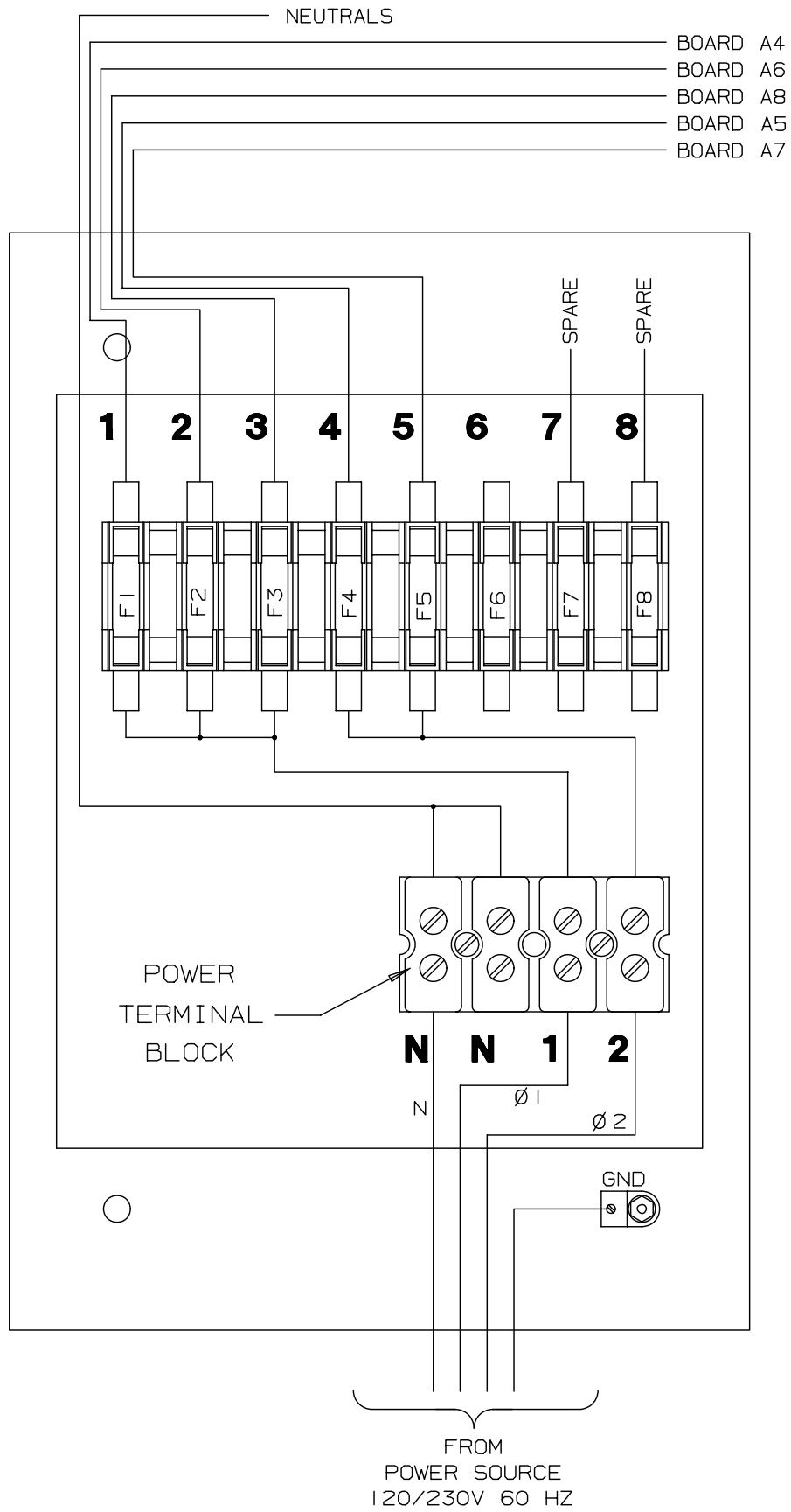

POWER WIRING

6.5 Controller Assembly Wiring

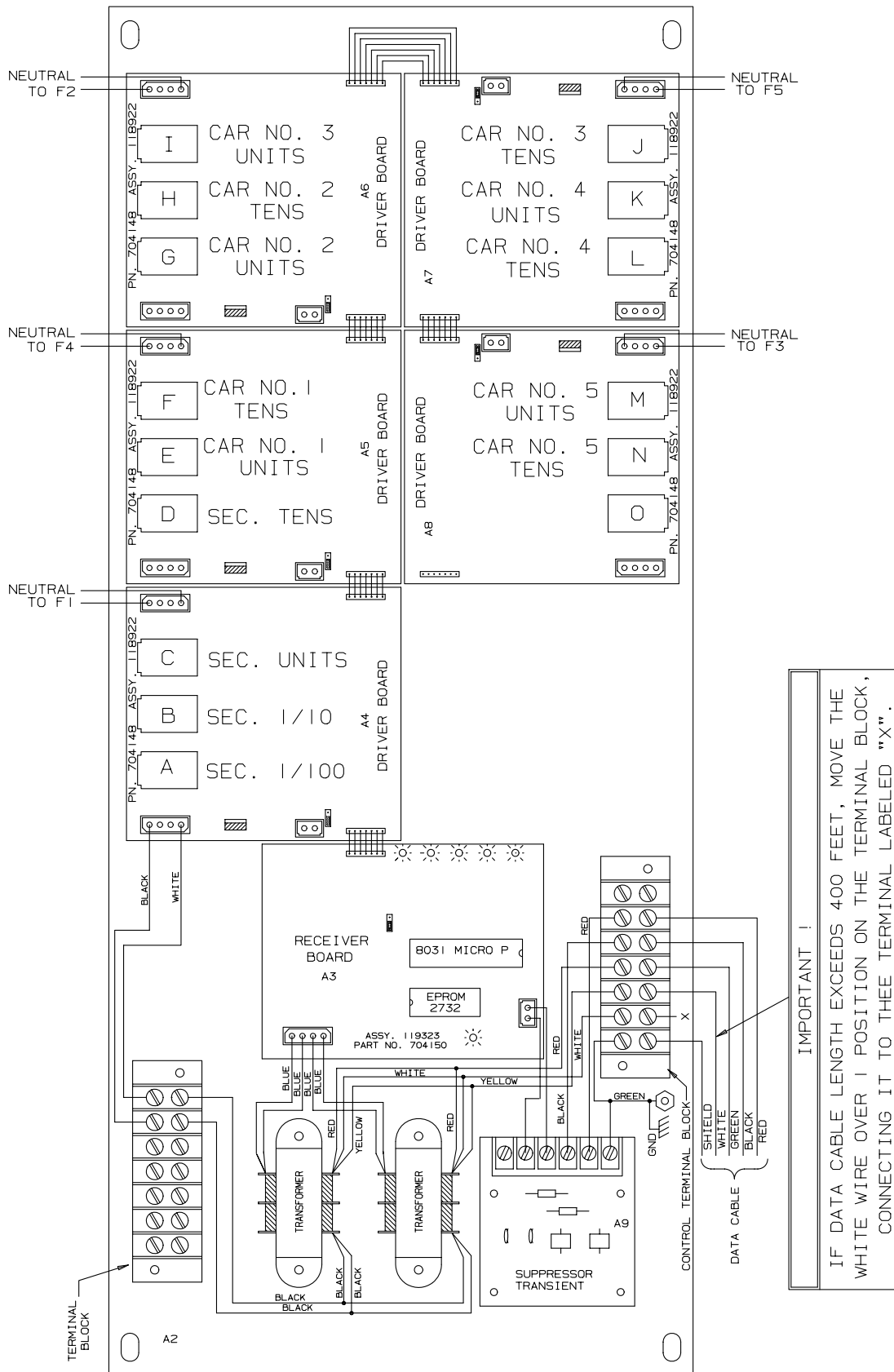

CONTROLLER ASSEMBLY

6.6 Microprocessor 4 X 7 Lamp Pattern (8 Bit)

6.7

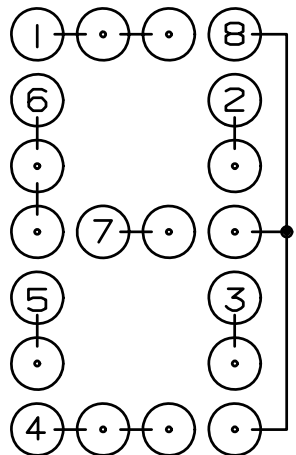
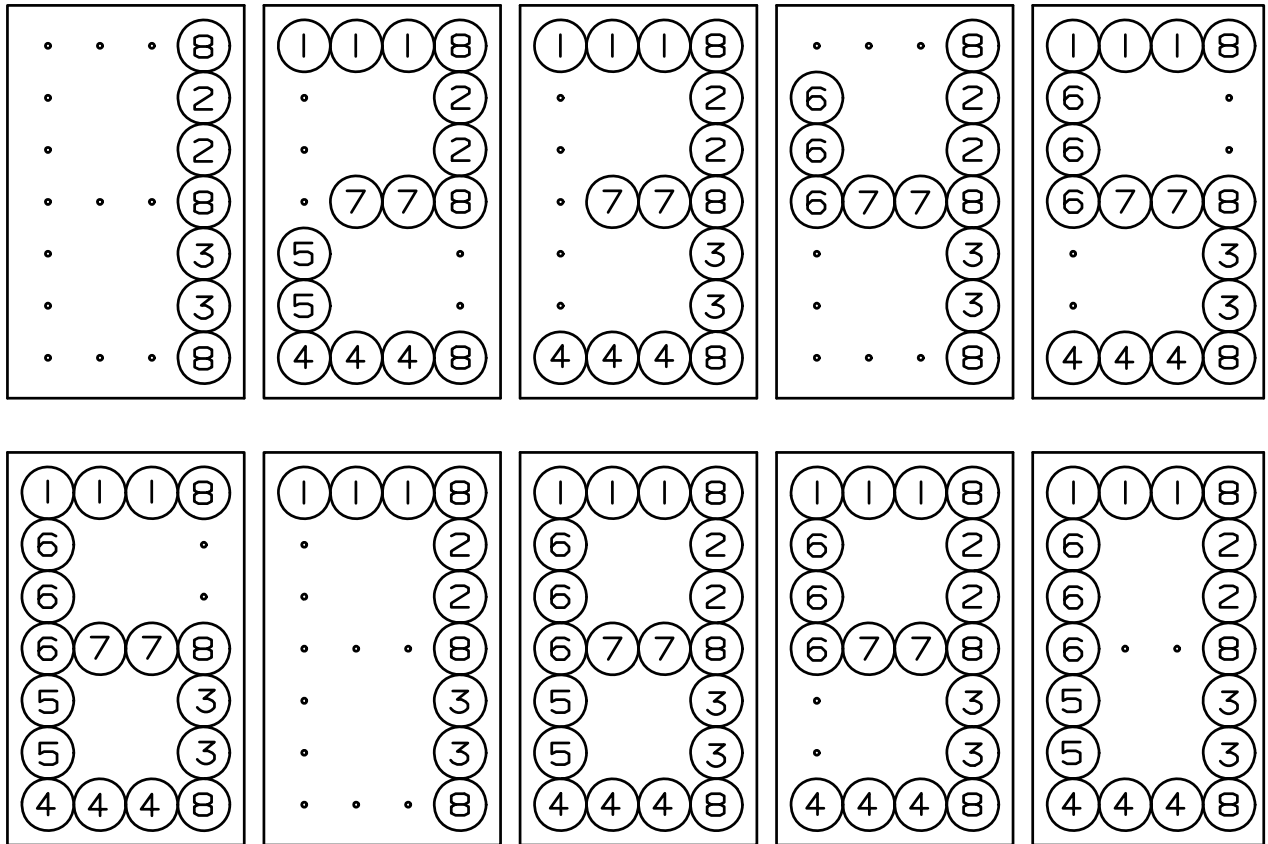

NUMERALS

	0	1	2	3	4	5	6	7	8	9
1	0	.	2	3	.	5	6	7	8	9
2	0	1	2	3	4	.	.	7	8	9
3	0	1	.	3	4	5	6	7	8	9
4	0	.	2	3	.	5	6	.	8	9
5	0	.	2	.	.	.	6	.	8	.
6	0	.	.	.	4	5	6	.	8	9
7	.	.	2	3	4	5	6	.	8	9
8	0	1	2	3	4	5	6	7	8	9

MICROPROCESSOR 4 X 7 (8 BIT) LAMP PATTERN

6.8 Figuregram Wiring

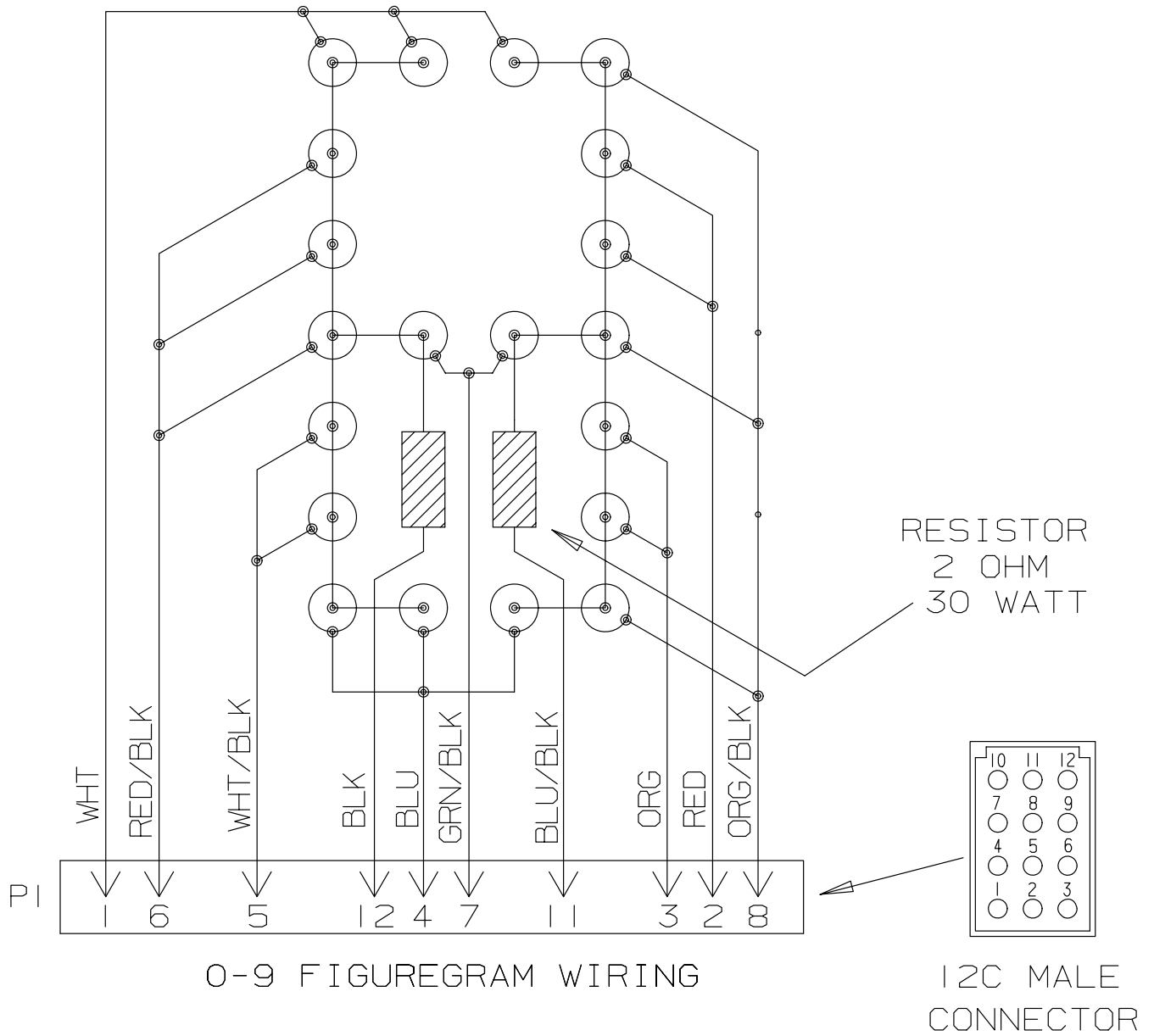

8 BIT FIGUREGRAM WIRING

6.8 Jumper Location on 3 Position System

All of the 3 position drivers and receivers are identical except for the jumper on each board. Make sure the jumpers are set for the model of scoreboard you are installing them into.

- (A) On the receiver board (refer to figure); Jumper pins 2 & 3 for models MP-3385, MP-3312, MP-3529, and MP-3549. Jumper pins 1 & 2, for all other models.
- (B) On the driver board (refer to figure); Jumper pins 1 & 2, for use of a horn. Jumper pins 2 & 3, for all others.

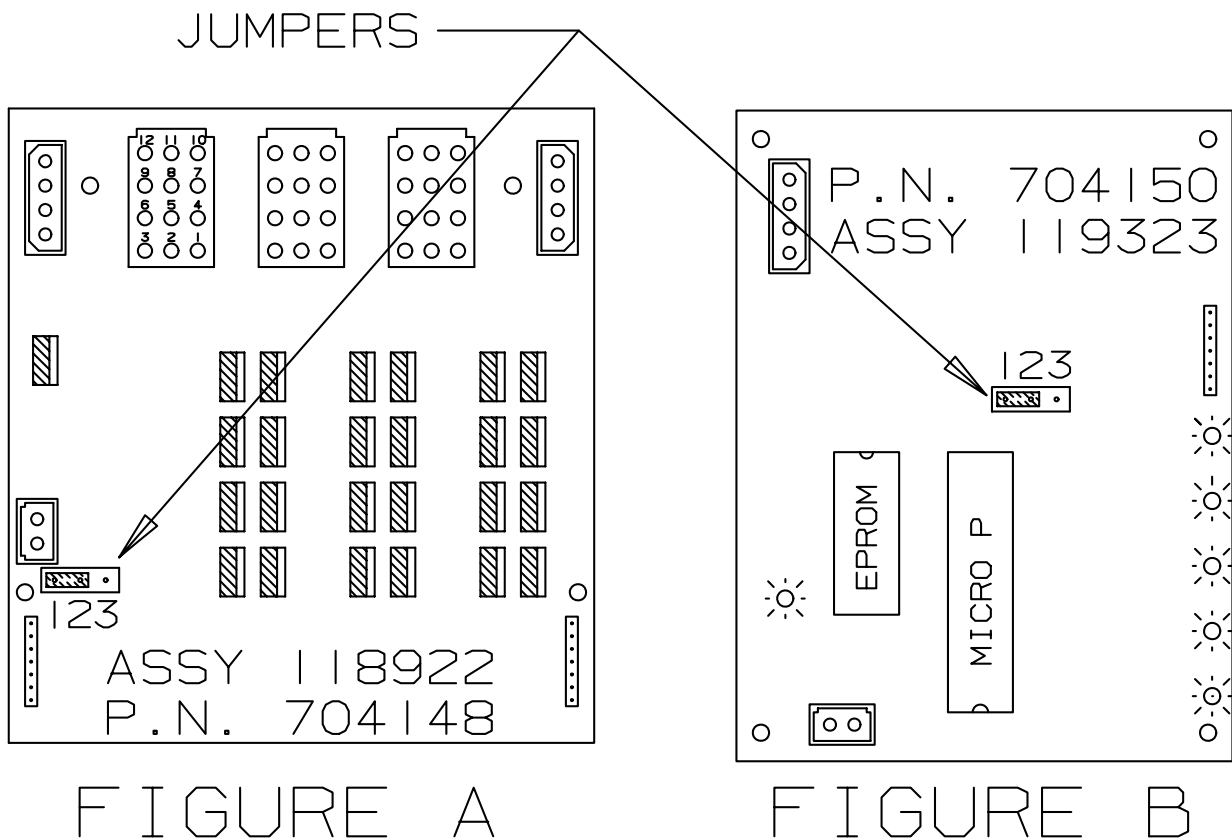

JUMPER LOCATION

6.9 Triac Placement

The triac is the switch that controls the figuregram lamps. The triacs for any given figuregram are adjacent to the twelve pin connector on the driver board that controls that figuregram. Shown below is the triac placement and bit designation relative to the figuregram bit pattern.

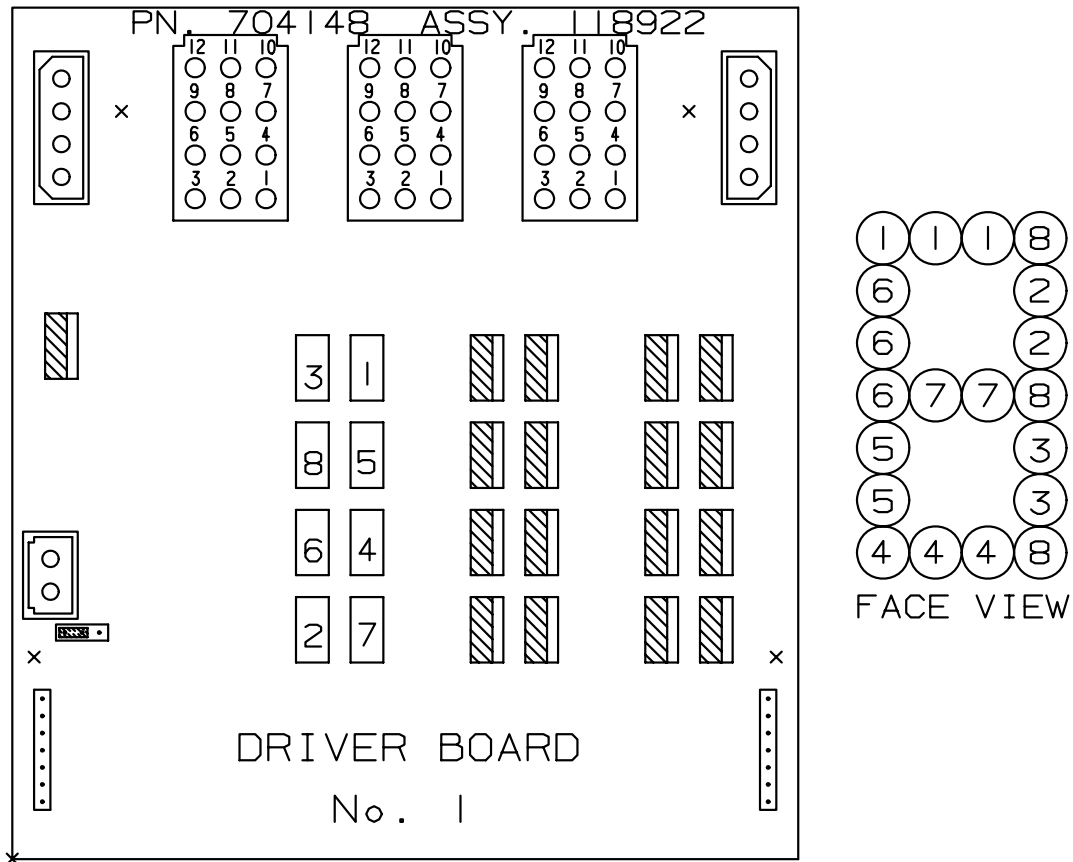

MP TRIAC PLACEMENT

6.10 Installation Drawing

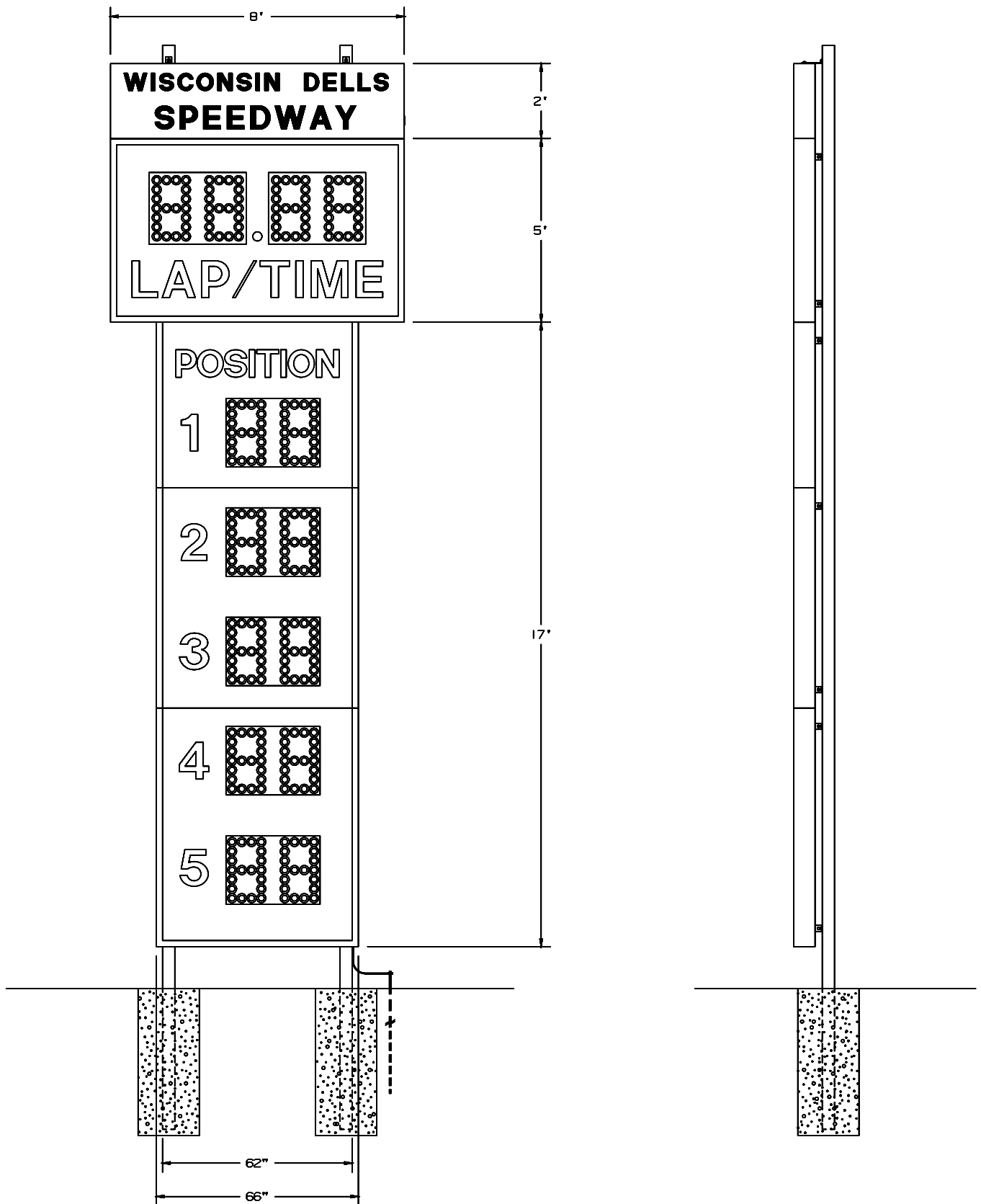

INSTALLATION DRAWING