



OPERATING INSTRUCTIONS AND SERVICE MANUAL

FOOTBALL SCOREBOARD

MODEL MP-3448 WITH MP-3000 CONTROL

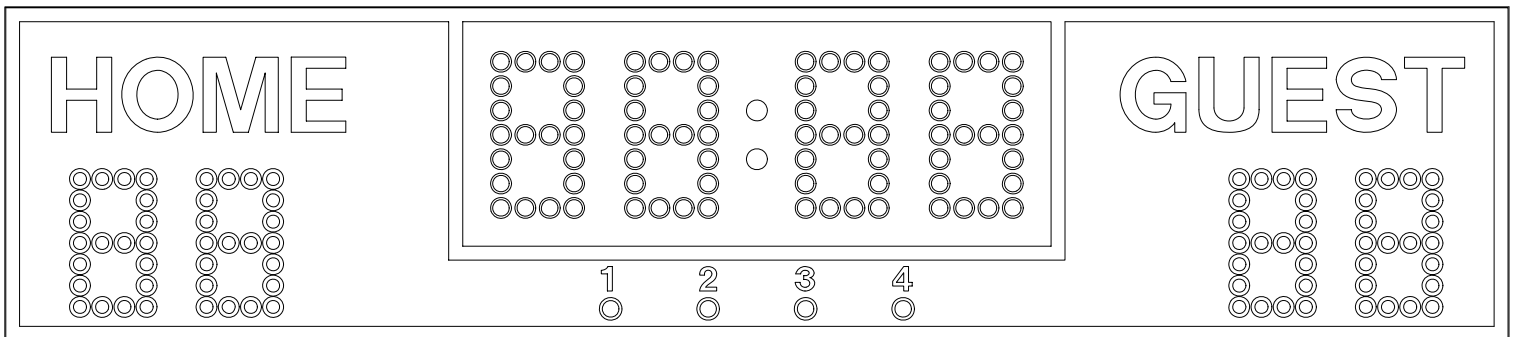

TABLE OF CONTENTS

1 General Information

- 1.1 Description
- 1.2 Identification
- 1.3 Damage
- 1.4 Damage Claim Procedure

2 Installation

- 2.1 General Information
- 2.2 Installation
- 2.3 Electrical Connection

3 Control Console Operation

- 3.1 Scoreboard Power
- 3.2 Control Console Display
- 3.3 Control Console Power
- 3.4 Initializing Scoreboard
- 3.5 Time Setting and Control
- 3.6 Team Scores
- 3.7 Horn (Optional)
- 3.8 Yards to Go, Ball On, Down, and Quarter
- 3.9 Dimmer
- 3.10 Track Operation
- 3.11 Baseball Conversion (Optional)

4 Maintenance and Troubleshooting

- 4.1 Introduction
- 4.2 Test Equipment
- 4.3 Troubleshooting
- 4.4 Troubleshooting Guide

5 Replacement Parts List

- 5.1 Scoreboard Display Parts
- 5.2 Controller Assembly

6 Diagrams

- 6.1 Control Console Keyboard Layout (Slipsheet)
- 6.2 Scoreboard Layout with Floating Time Control (C-7430)
- 6.3 Junction Box Wiring (B-121273)
- 6.4 Power Wiring
- 6.5 Controller Assembly Wiring and Layout (D-170203)
- 6.6 Microprocessor 4 x 7 Lamp Pattern (8 Bit)
- 6.7 Figuregram Wiring Diagram (C-13137)
- 6.8 Jumper Location on 3 Position System
- 6.9 Triac Placement Diagram
- 6.10 Installation Drawings (C-10827-2 and B-151501)

1. GENERAL INFORMATION

1.1 DESCRIPTION

Your All-American scoreboard has been carefully inspected and tested before leaving the factory. It is possible, however, that components may be loosened or forced out of adjustment in transit. If this occurs, follow the troubleshooting guide (section 4). If equipment then fails to operate, contact immediately:

ALL-AMERICAN Service Department
EVERBRITE Corporation
P.O. Box 97
Pardeeville, WI 53954
Telephone: (608) 429-2121
Toll Free: 800-356-8146

Parts being returned for repair are to be sent to:

ALL-AMERICAN Service Department
EVERBRITE Corporation
401 S. Main Street
Pardeeville, WI 53954

NOTE

If you need to send parts in for repair, please call the ALL AMERICAN service department for a returned goods authorization (RGA) number.

1.2 Identification

ALL-AMERICAN uses a 4 digit serial number for scoreboard identification. The serial number tags are located on the back of the control console and the lower right hand corner on the face of the scoreboard display. When contacting the factory for assistance it is important that the model number and serial numbers are known.

1.3 Damage

Upon receipt, check for visible damage. If this occurs, or if damage is found after shipment has been accepted, follow the damage claim procedure.

1.4 Damage Claim Procedure

An instruction sheet is enclosed advising the consignee in case of damage in transit. If damage is noted at the time of delivery, consignee must obtain an 'Inspection of Bad Order' from the delivering carrier. In order to process your claim, this must be properly filled out with a complete statement of all damage and it must be signed by the carrier.

If damage is discovered after delivery, you should call the delivery company. Have them make out a Concealed Damage Report. Fifteen days after delivery are allowed, so this should be done promptly or it is impossible to process this claim.

Advise EVERBRITE corporation of necessary replacement parts, or repairs. Consignee will be invoiced and then should file a claim with the carrier to recover charges. To file your claim follow this procedure:

- (A) Cost of replacement parts or repair charges are invoiced to the carrier by the consignee.
- (B) The following documents, properly filled out, plus invoice, are forwarded to the trucking company in support of your claim:
 - (a) Original bill of lading
 - (b) Original paid freight bill
 - (c) Certified copy of original invoice
 - (d) Standard form for presentation of loss and damage claim

2. INSTALLATION

2.1 General Information

Shipping papers accompany each scoreboard. Check carefully to see that you receive the following:

- 1 ea Football Display
- 1 ea Control Console
- 1 ea Service Manual
- 1 ea Mounting Hardware Package
- 1 ea Press Box Junction Box
- ? ft Control Cable (if ordered)
- 1 ea Horn (if ordered)

IMPORTANT!

The MP-40 cable supplied by ALL AMERICAN SCOREBOARDS for use on the Microprocessor based scoreboards is specifically designed for this system. Use of a substitute cable may void the warranty on the scoreboard!

2.2 Installation

Select the location best suited for visibility by the majority of spectators. Preferred position is facing east or north to avoid direct sunlight on the face of the scoreboard, if day games are played.

For permanent mounting to uprights, see the enclosed installation drawing in Section 6.

The MP-40 data cable carries only low voltage signals and therefore can be installed with or without conduit. Consult Section 6 for junction box and scoreboard wiring.

2.4 Electrical connections

The MP-3448 scoreboard requires two 110 V. 15 AMP AC circuits, or one 110 V. 30 AMP circuit for the exclusive use of the scoreboard.

IMPORTANT !!!

To protect the MP-3000 control from damage, it is advisable to disconnect the control and store in a dry secure area when not in use.

NOTE

This equipment is **ETL** (Electronics Testing Laboratories) **CSA** and **NRTL** approved and complies with the requirements in part 15 of the FCC rules for a class A computing device. Operation of this equipment in a residential area may cause unacceptable interference to radio and television reception, requiring the operator to take whatever steps are necessary to correct the interference.

3. CONTROL CONSOLE OPERATION

3.1 Scoreboard Power

Turn on the branch circuits to the scoreboard. The Home and Guest scores will show "0".

3.2 Console Display

The 2 line by 20 character Liquid Crystal Display module displays the scoreboard information entered from the keyboard. The following information is displayed continuously: Time, Home and Guest scores, Yards To Go, Ball On, Down, Quarter, Ball Possession, and Auto Horn Enable.

3.3 Console Power

Plug the control console cable into the Press Box junction box.

Push **ON/OFF** once to turn the console on.

Push **ON/OFF** a second time to shut the console off.

When first turned on; the console display should show as follows:

**SCOREBOARD CONTROL
1991 VERSION 3.3**

3.4 Initializing Scoreboard

Enter the two digit code (**61**) shown in the lower left corner of the keyboard as in the following example:

Push **CODE** **6** **1** **ENTER** .

When the proper code has been entered, the console display will show as follows.

**0 :00 0
H**

The scoreboard display will now show :00 in the time section.

3.5 Time Setting and Control

To set a 15 minute period, key in the following:

SET **1** **5** **0** **0**
0 **ENTER** .

Any time up to 99:59 may be preset in a similar manner.

The **UP/DN** key determines the timer mode. When in the UP mode an arrow up symbol is displayed next to the time on the LCD display. If in the DOWN mode there is no arrow displayed.

Switching the time toggle switch to the IN and OUT position, starts and stops the timer.

Push **RESET** to return the timer to the previously set value.

3.6 Team Scores

The Home and Guest Scores can be changed in five different ways.

- (A) To add 1 to the existing score: Push **+1**.
- (B) To add 6 to the existing score: Push **+6**.
- (C) To add 3 to the existing score: Push **+3**.
- (D) To directly enter or correct a score: Push Home or Guest **SCORE** followed by the desired number, then **ENTER**.

Example: Present Home Score is 15. Change the score from 15 to 23.

Push: Home **SCORE** **2** **3** **ENTER**.

- (E) To clear the score: Push **SCORE** **CLEAR**.

3.7 Horn (Optional)

The horn will blow for 1/2 second each time **HORN** is pressed.

The horn will blow automatically at the end of each period for 2 seconds.

The automatic horn function may be disabled by using the **AUTO HORN** key.

An 'H' is displayed on the LCD when this function is enabled.

3.8 Quarter

Entries to the above function are made in the same manner as direct entry for Team Scores.

3.9 Dimmer

Push **DIMMER** to dim the lamps during night use.

3.10 Track Operation

For track operation, Push **1/10 TRACK**. The timer will now count up from zero and the 1/10 second digit will display on the control console and on the scoreboard if the scoreboard has the 1/10 second digit.

WARNING

110 VAC wires are exposed whenever the cover over the controller assembly is removed from the scoreboard. Use extreme caution during troubleshooting or repair. To avoid possible damage to equipment or personal injury, always turn off the main power before removing the cover or replacing assemblies, or replacing lamps.

4. MAINTENANCE AND TROUBLESHOOTING

4.1 Introduction

This section gives maintenance and troubleshooting information. Included are troubleshooting guides for typical scoreboard malfunctions. If the cause of a problem cannot be determined, please contact the Customer Service Department.

4.2 Test Equipment

A simple analog or digital voltmeter will be sufficient for all user repairable problems. Printed circuit boards requiring troubleshooting should be returned to the factory.

4.3 Troubleshooting

Whenever possible, follow the troubleshooting guides prior to contacting the Customer Service Department. If a problem not described in the guides exists, contact the customer service department immediately. Refer to the diagrams provided for assistance in troubleshooting scoreboard malfunctions.

4.4 Troubleshooting Guides

(A) Scoreboard doesn't light and console doesn't work

- (a) Check that the main power switch is turned on.
- (b) Replace any defective or blown fuses.

- (c) Check the power connections and voltages at the scoreboard.
- (d) Contact the Customer Service Department.

(B) Scoreboard digits don't light, but the console works

- (a) With the main power switch "off"; remove the cover over the controller assembly.
- (b) Check all connections.
- (c) Turn the main power "on".
- (d) If the scoreboard still doesn't light, check the transformer voltage going to the receiver PCB (printed circuit board) assembly (blue wires) using a voltmeter set on the 12 VAC or higher scale.

If the voltage is less than 8 VAC contact the Customer Service Department.

If the voltage is between 8-12 VAC see the replacement parts list for a receiver PCB assembly, and contact the Customer Service Department.

(C) The scoreboard digits light but the console doesn't work

- (a) Check for continuity between the scoreboard and the junction box.
- (b) If an open circuit is found, the problem is either the cable or a cable connection.
- (c) If the continuity test checks good, check the voltage between the green wire and the white wire in the junction box, using a voltmeter set on the 12 VAC or higher scale.

If the voltage is 0 VAC see the controller parts list for a transformer assembly.

If the voltage is less than 8 VAC consult the controller wiring diagram for instructions on long cable compensation.

If the voltage is between 8 VAC and 12 VAC contact the Customer Service Department.

(D) The scoreboard digits light, the console works, but there is no control of the scoreboard.

- (a) Check the voltage between the black and red wires in the junction box with a voltmeter set on the 3 VDC or higher scale. The voltage should read somewhere between 2-3 VDC when the console is working properly.
- (b) If the voltage is 0 VDC contact the Customer Service Department for assistance.
- (c) If the voltage is correct, (2-3 VDC) check that this reading also appears at the scoreboard.
- (d) If the correct voltage also appears at the scoreboard, see the replacement parts

list for a receiver PCB assembly.

- (E) The scoreboard works, but some lights stay on all the time
 - (a) With the main power "OFF", switch the plug from the bad digit with the plug for a known good digit.

EXAMPLE: Plug "C" into "D" and "D" into "C" locations.

- (b) Turn the power back on. If the same lamps remain lit all the time, the problem is a shorted lamp socket. If the lamps on a different digit now stay lit all the time, the problem is on the driver PCB assembly. See the replacement parts list for the proper replacement part.

IMPORTANT !!!

In this scoreboard the 120 volt line is on the lamp socket all the time, and the common is switched to turn the lamps on and off. For this reason, to avoid damage to the equipment or personal injury, it is important to turn the main power off when changing the lamps.

- (F) The scoreboard works, but some lights do not come on.
 - (a) Check for burned out lamps.
 - (b) Check for a broken wire or bad connection on the 12 pin connector.
 - (c) See the replacement parts list for the proper replacement driver board.

5. REPLACEMENT PARTS LIST

5.1 Scoreboard Display Parts

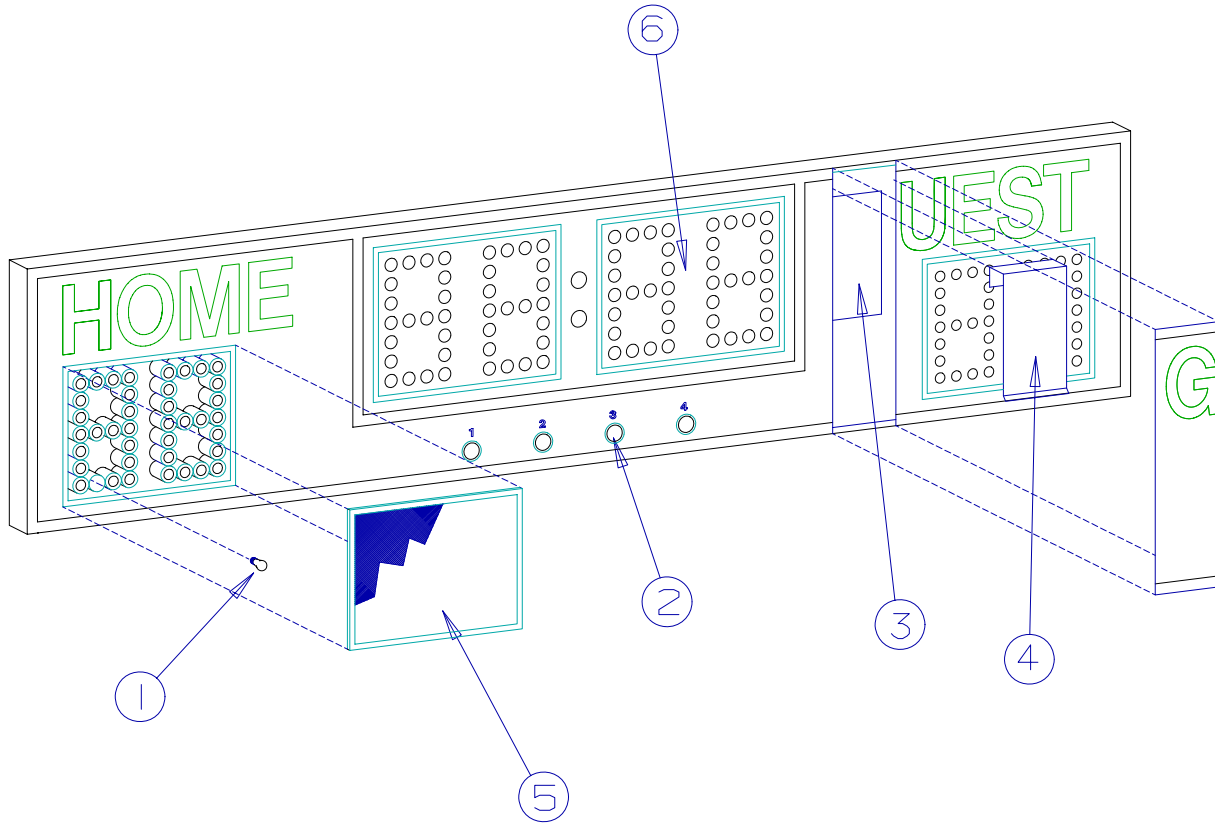

figure 1

DISPLAY ASSEMBLY

REPLACEMENT PARTS LIST (MP-3448 Football)

fig.& index	MFG PART NUMBER	DESCRIPTION	REF DES	VENDOR PART #
1- 1-1 1-1A 1-2	HB004300 850022 850030 850030	Display Assembly Lamp, 15W/130V Clear Lamp, 25W/130V Clear Lamp, 25W/130V Clear		HB004300 15A15CL 25A19 GR CL 25A19 GR CL
1-3	SU479300	Controller Assembly, MP-3448 *****SEE DETAIL FIGURE 2*****	A2	SU479300
1-4 1-5 1-6 1-7 1-8	150660 705909 705920 EL044100 121880	Rainshield Screen, Score Screen, Timer Resistor, 2 OHM 30 WATT Wire Wound Fuse, 15A 250V.	F1-F3	150660 705909 705920 HL-24-09Z ABC-15
	SU4450 HB005500 HB002300 SW005100 702785 EL053000 HB002400 WH009100 122763	Control Console Slipsheet Pair Transmitter PCB Assembly Toggle Switch, Connector, 5 Pin Male Cable LCD Display, 2 Line 20 Character Keyboard Assembly, Ribbon Cable Assembly, 14C 8" Enclosure,	A1 S1 P1	SU4450 HB005500 HB002300 SW005100 RM12BPG5P HB002400 WH009100
	151002 702786 150508	Press Box Junction Box, Connector, 5 Pin Female Cable, MP-40 Control	J1	151002 RM12BRD5S YR21233
	xxxxxx	Floating Time Control (W/6' pendant)		xxxxxx
	xxxxxx	Floating Time Control (W/160' Cable)		xxxxxx

5.2 Scoreboard Controller Assembly Parts

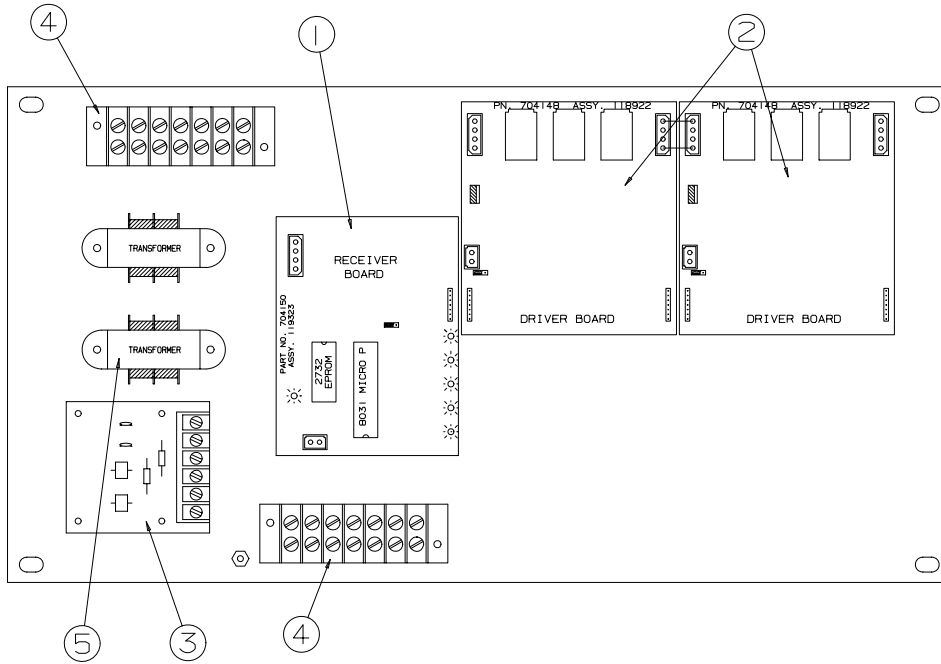

figure 2

CONTROLLER ASSEMBLY

REPLACEMENT PARTS LIST (MP-3448) Controller Assembly				
fig. & index	MFG PART NUMBER	DESCRIPTION	REF DES	VENDOR PART #
2-	SU479300	Controller Assembly	A2	SU479300
2-1	119323	Receiver PCB Assembly *** PROGRAM 3MP-CNT-V00***	A3	119323
2-2	118922	Driver PCB Assembly, 3 Position	A4-A6	118922
2-3	118522	Transient Suppressor PCB Assembly	A8	118522
2-4	701137	Terminal Block, 7C	TB1&2	670-7
2-5	700520	Varistor,		ERZ-C20DK201U
2-6	703719	Transformer, 8V/18V	T1/T2	CS-697
2-7	HB005600	Cover		HB005600
2-8	705723	Spacer, P.C.Board		LCBS-6-01

6. DIAGRAMS

6.1 Control Console Keyboard and Slipsheet Layout

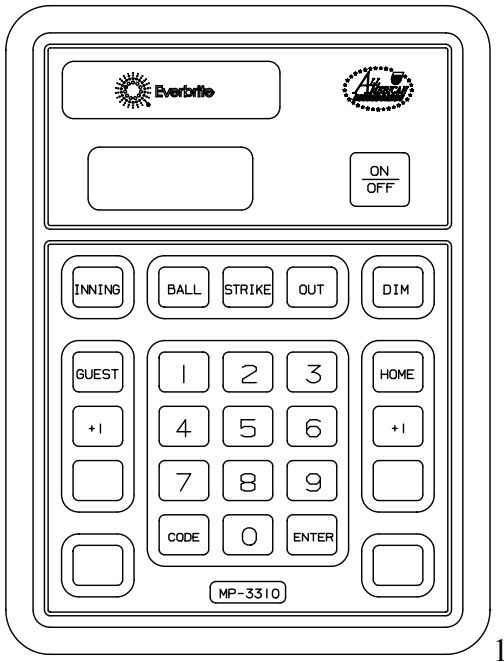

FOOTBALL

figure 3

CONSOLE KEYBOARD

6.2 Scoreboard System Layout

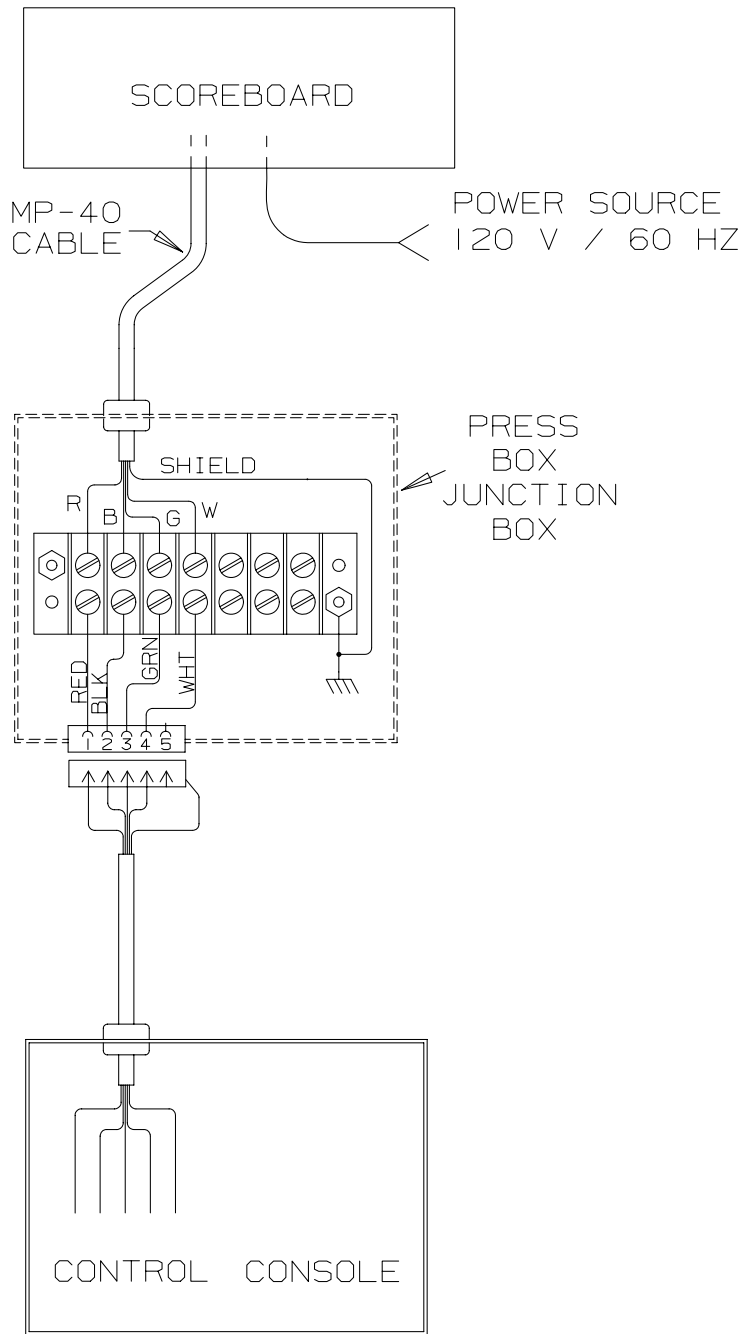

2

figure 4
SYSTEM LAYOUT

6.3 Single Junction Box Wiring

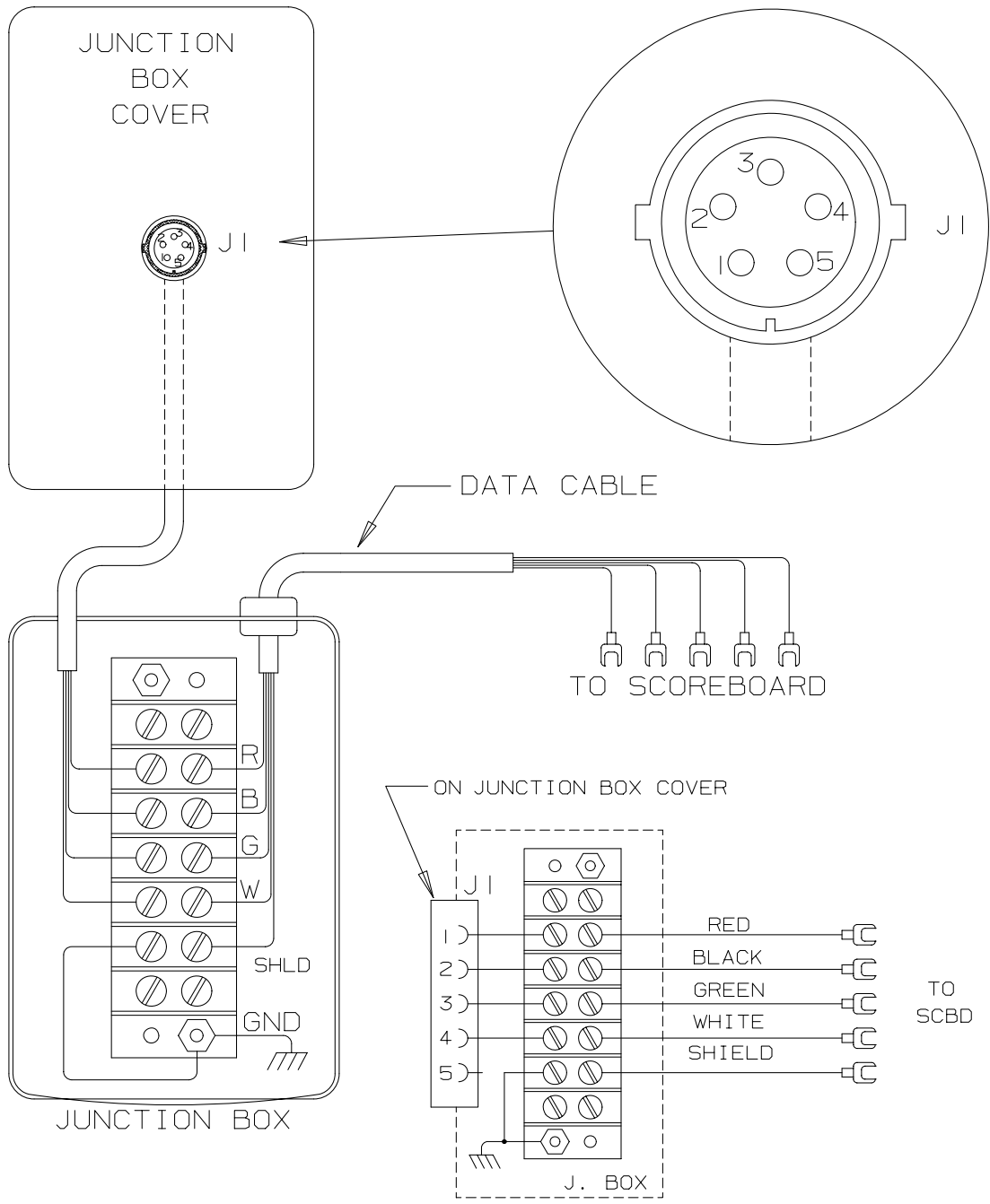

3

SINGLE JUNCTION BOX WIRING

6.4 Power Wiring

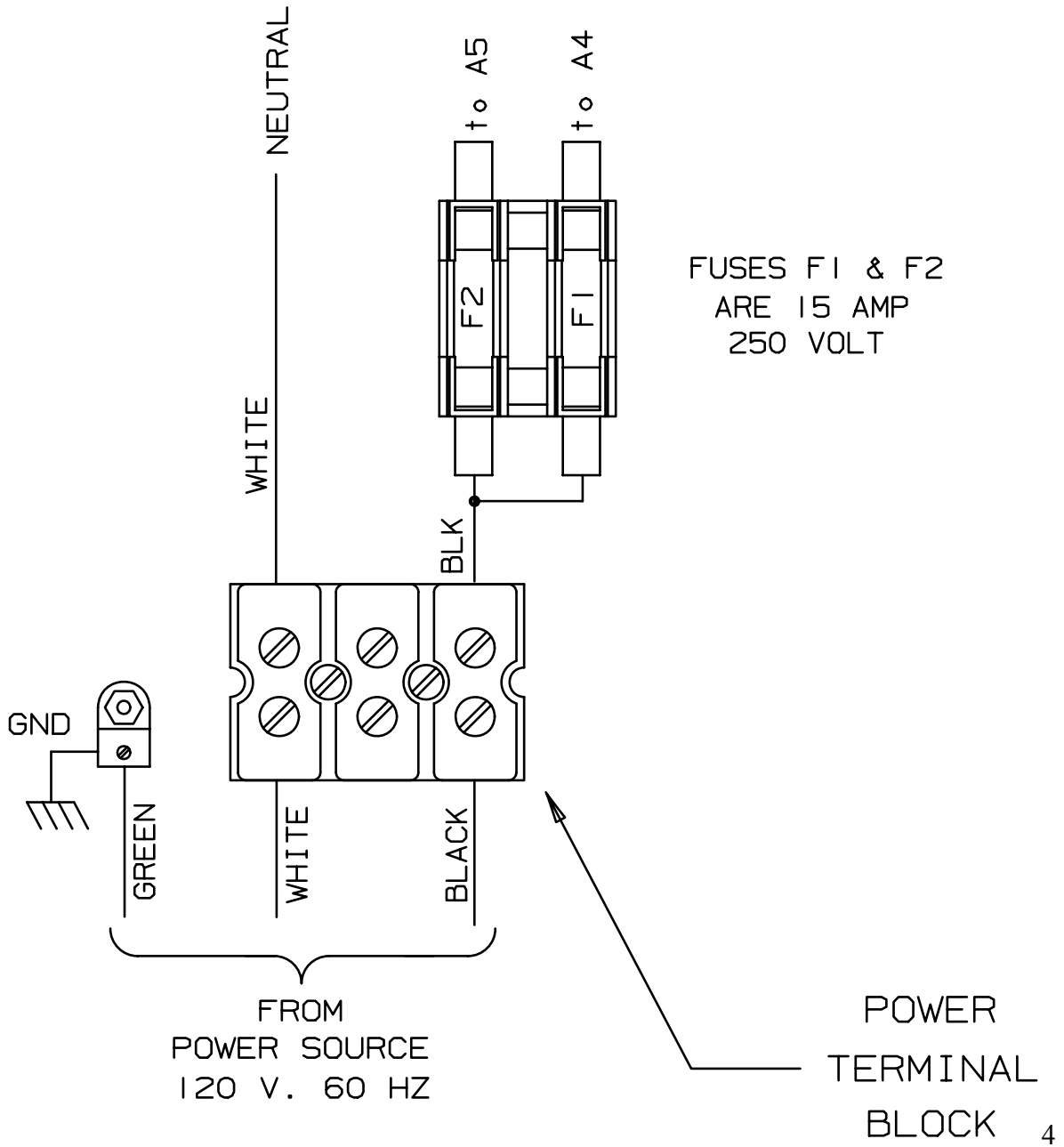

POWER WIRING

6.5 Controller Assembly Wiring

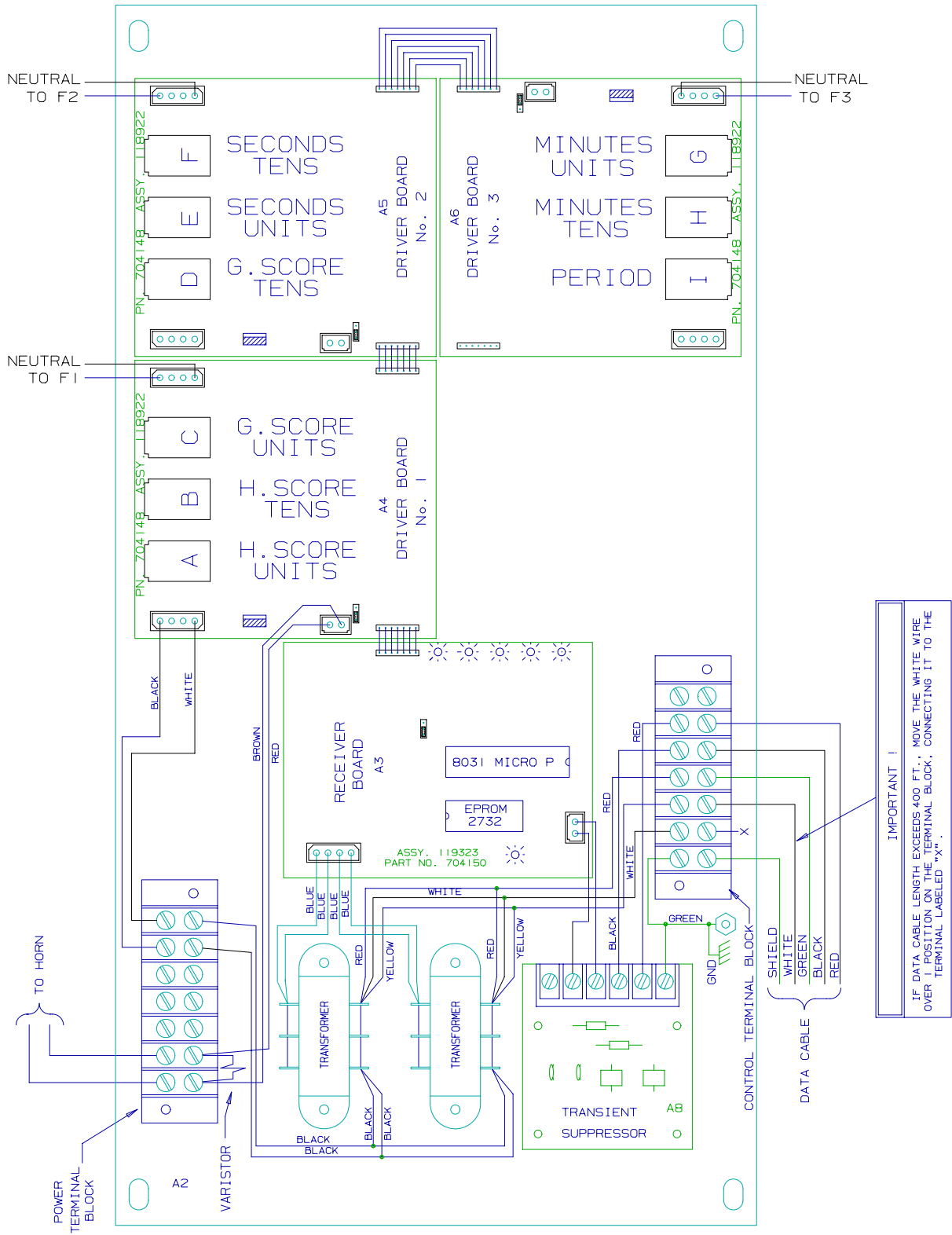

CONTROLLER ASSEMBLY

6.6 Microprocessor 4 X 7 Lamp Pattern (8 Bit)

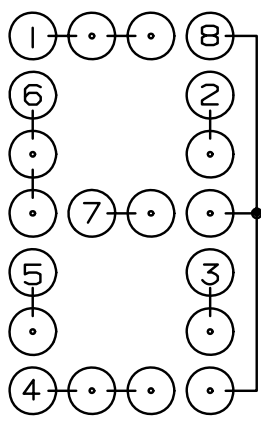
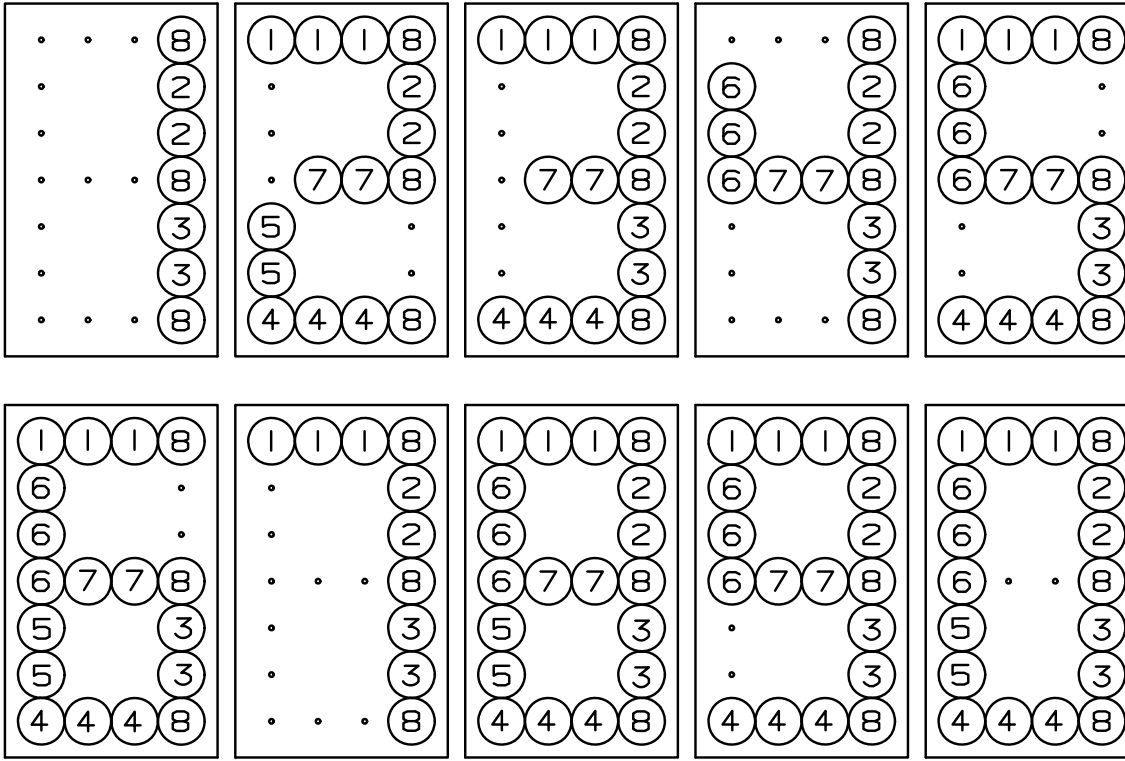

NUMERALS

	0	1	2	3	4	5	6	7	8	9
1	0	.	2	3	.	5	6	7	8	9
2	0	1	2	3	4	.	.	7	8	9
3	0	1	.	3	4	5	6	7	8	9
4	0	.	2	3	.	5	6	.	8	9
5	0	.	2	.	.	.	6	.	8	.
6	0	.	.	.	4	5	6	.	8	9
7	.	.	2	3	4	5	6	.	8	9
8	0	1	2	3	4	5	6	7	8	9

6

MICROPROCESSOR 4 X 7 (8 BIT) LAMP PATTERN

6.7 Figuregram Wiring

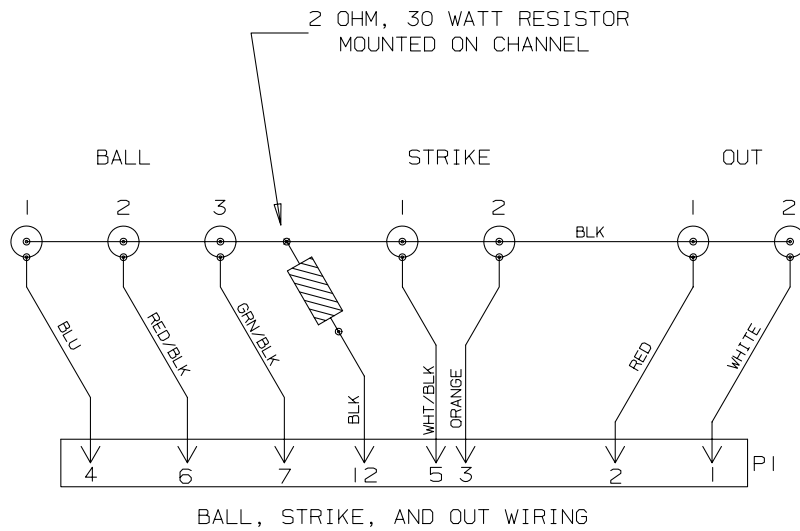
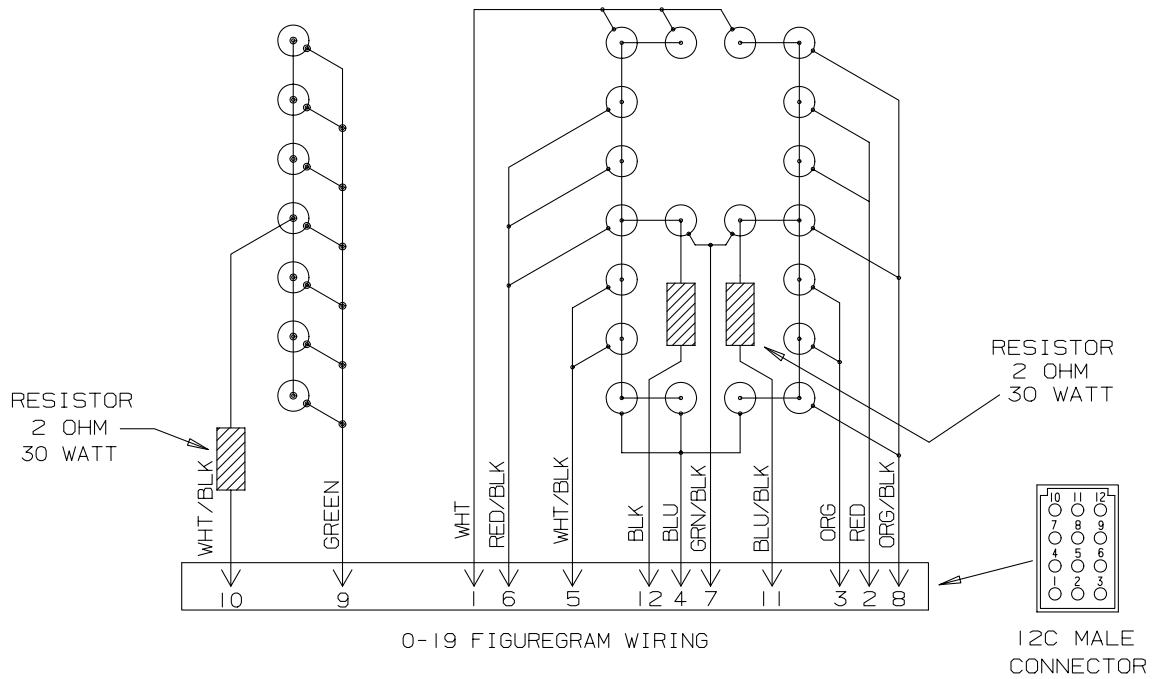

FIGUREGRAM WIRING

7

6.8 Jumper Location on 3 Position System

All of the 3 position drivers and receivers are identical except for the jumper on each board. Make sure the jumpers are set for the model of scoreboard you are installing them into.

- (A) On the receiver board (refer to figure 11); Jumper pins 2 & 3 for models MP-3385, MP-3312, MP-3529, and MP-3549. Jumper pins 1 & 2 for all other models.
- (B) On the driver board (refer to figure 10); Jumper pins 1 & 2 for use of a horn. Jumper pins 2 & 3 for all others.

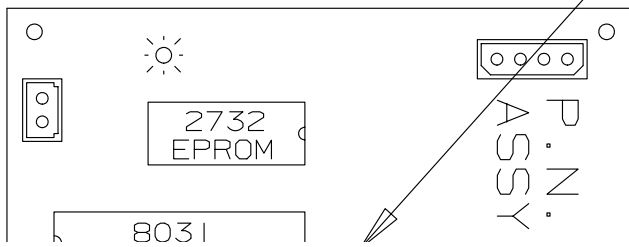
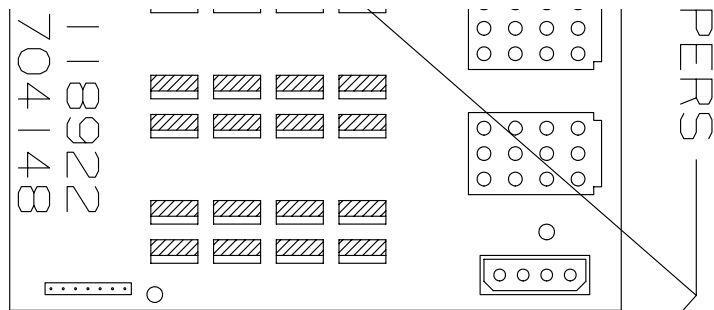

figure 10

8
figure 11

JUMPER LOCATION

6.9 Triac Placement

The triac is the switch that controls the figuregram lamps. The triacs for any given figuregram are adjacent to the twelve pin connector on the driver board that controls that figuregram. Shown below is the triac placement and bit designation relative to the figuregram bit pattern.

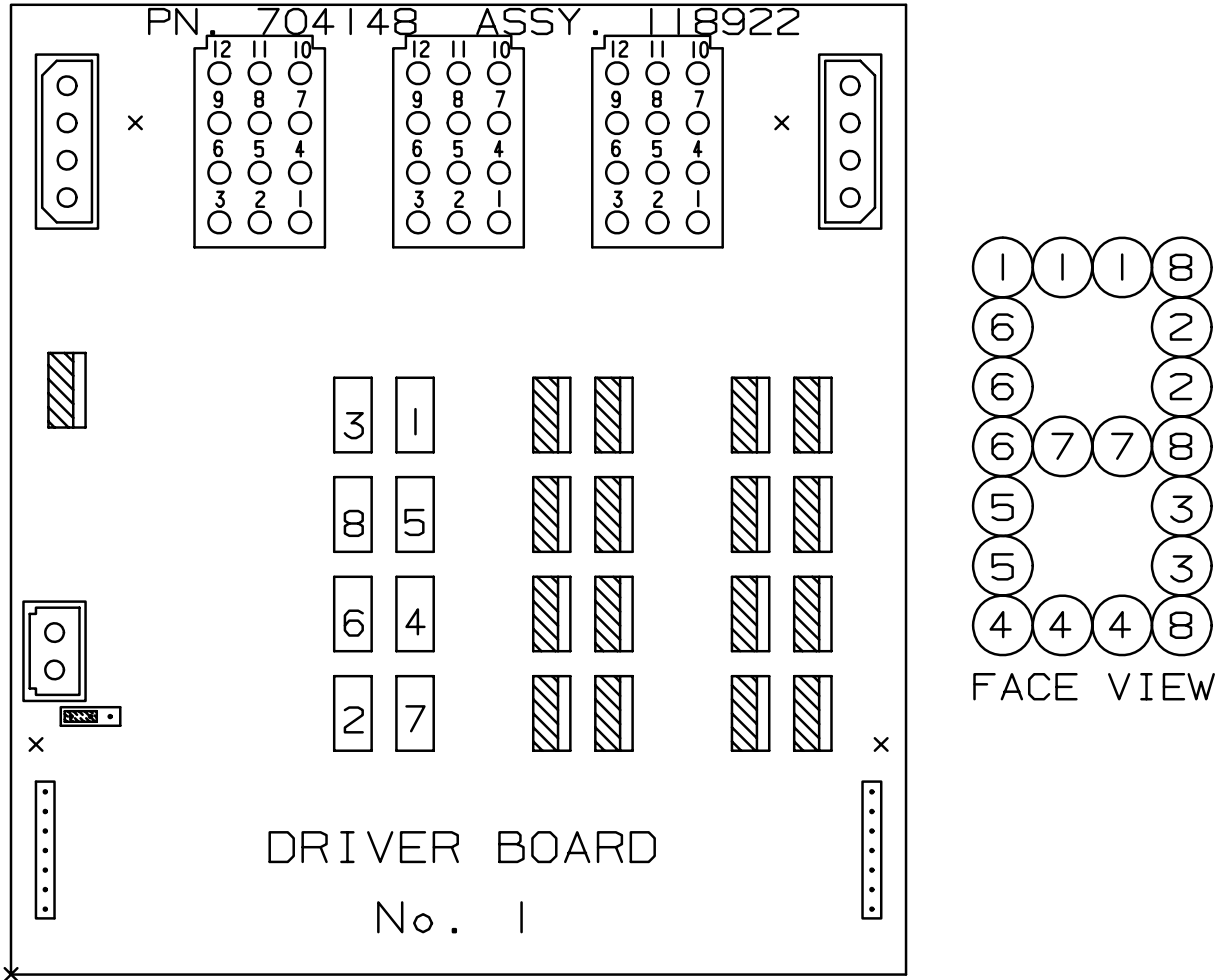

MP TRIAC PLACEMENT

6.10 Installation Drawing

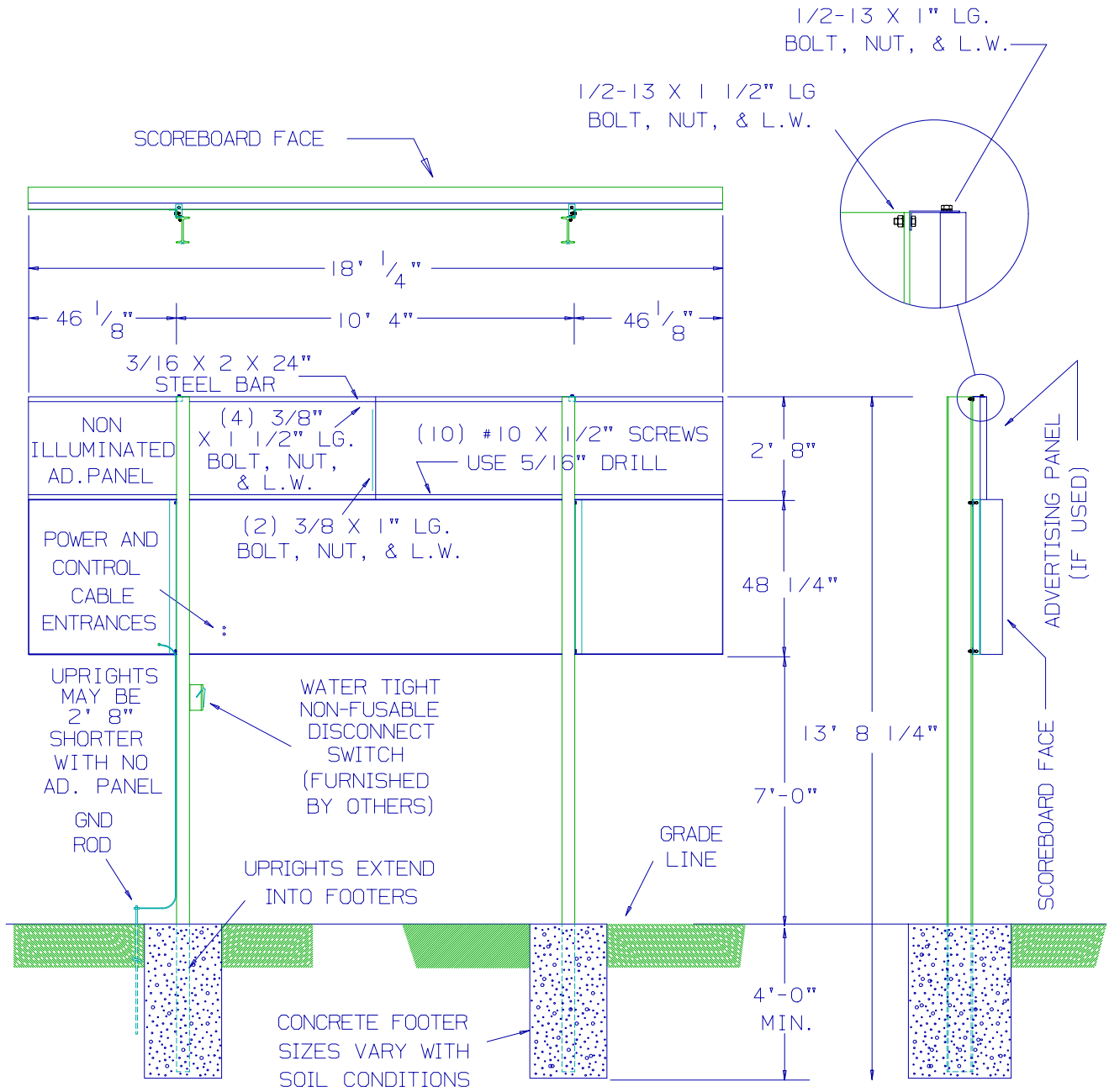

8" X 18.4 lb/ft X 21' 2" long STRUCTURAL STEEL I BEAM
 (2) REQ'D OR (2) STD 5" X 10" DOUGLAS FIR TIMBERS
 (FURNISHED BY OTHERS) OR SEE ALTERNATE MOUNTING DETAIL

6.10 (cont.) Installation Cont. and Alternate Methods

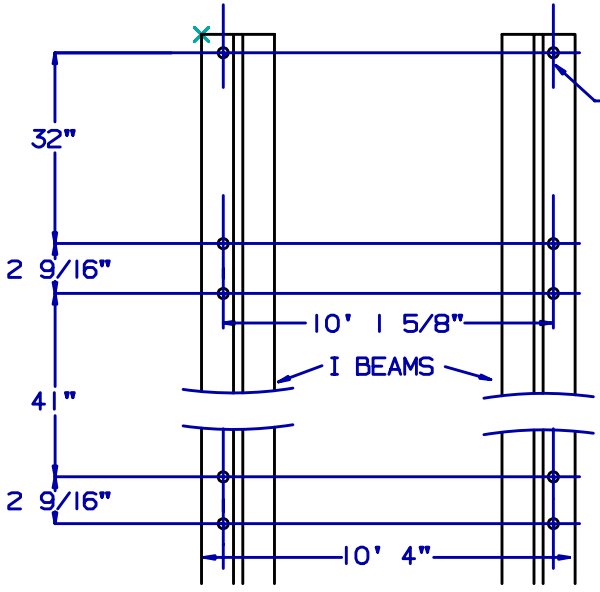
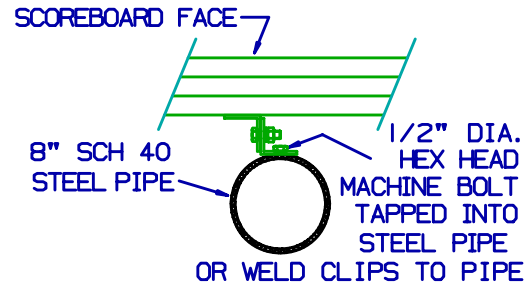
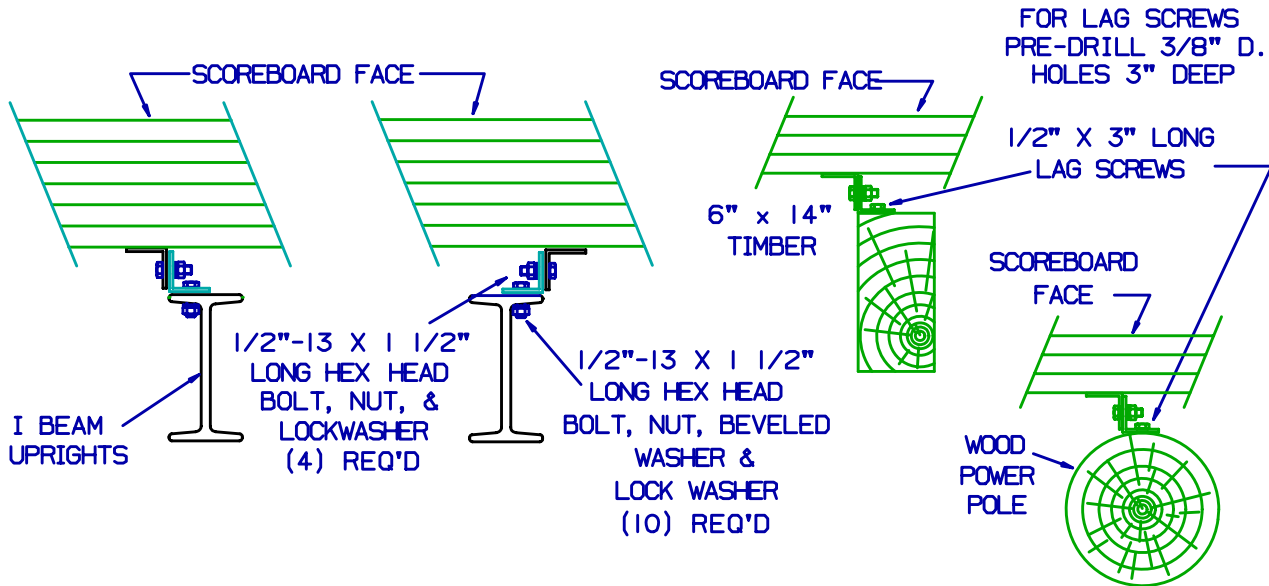

FRONT VIEW MOUNTING DETAIL

