

ALL AMERICAN

SCOREBOARDS™

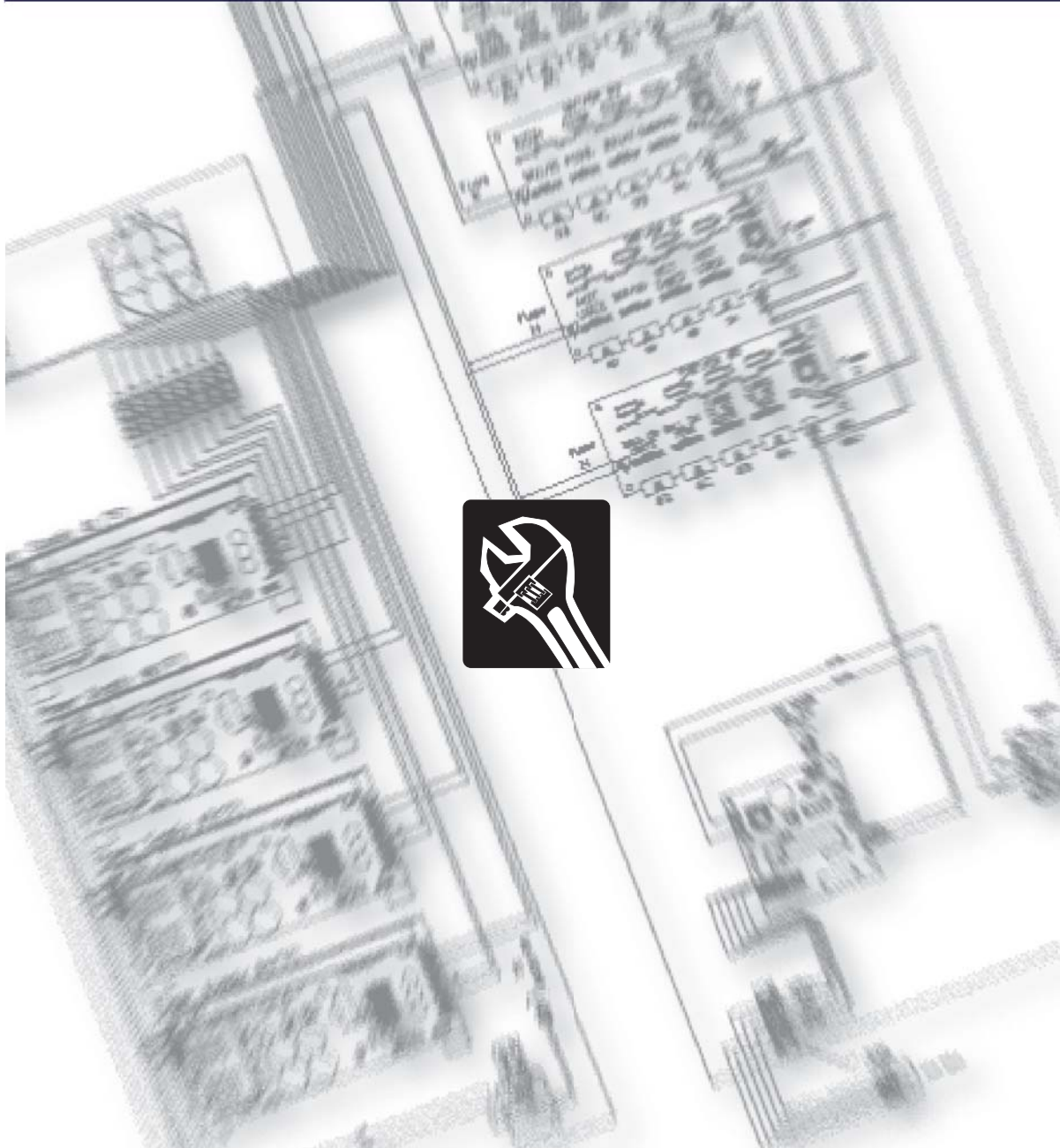

Everbrite

Service Manual | Model MP-7814

Rev. 1/31/08

© Copyright All American Scoreboards 2005

This is the exclusive property of All American Scoreboards® a division of Everbrite® LLC. Use of or duplication of this document in any manner without the expressed written consent of All American Scoreboards® is prohibited.

The information contained in this document is subject to change without notice and should not be construed as a commitment by All American Scoreboards®.

All American Scoreboards® assumes no responsibility for any errors that may appear in this document. Nor does it make expressed or implied warranty of any kind with regard to this material, including, but not limited to, the implied warranties of merchantability and fitness for a particular purpose.

All American Scoreboards® shall not be liable for incidental or consequential damages in connection with, or arising out of the furnishing, performance, or use of this document and the program material, which it describes.

Trademarks Credits

All American Scoreboards® is a registered trademark of Everbrite® LLC.
Everbrite® is a registered trademark of AAS LLC.

Introduction

All American Scoreboards (AAS) has a proud history of providing scoreboards to customers throughout the world. From professional sports to the local church league, we pride ourselves in delivering satisfaction to the customer.

The AAS LED Game Display System is based on Display Arrays of remotely controlled LED numeric modules that provide greater readability than other typical LED digits. Game changes are easily and safely accomplished from inside the dug-out or press box.

Long-life, energy-efficient LED's require no maintenance, are microprocessor controlled and provide a 140° wide viewing angle for maximum exposure to the spectators. Operational input is easily accomplished using a Keypad/Console that incorporates an LCD monitor. This control is done using a radio or hard-wire configuration.

This affordable and user friendly system uses a wide range of digit sizes to give your customers the scores, at whatever distance you need. AAS is proud to offer an Electronic Game Display System that truly sets itself apart from the rest of the industry.

THESE STANDARD FEATURES EXIST FOR ALL AAS BOARDS

- 22 gauge steel face panels
- Front access panels for easy servicing
- Extruded aluminum cabinet
- Kynar® painted finish
- All solid state microprocessor controlled system
- UL® (Underwriters Laboratories) approved
- Standard colors: Blue, Black, Green, Red, Navy, Purple, Maroon
- 22 gauge galvanized back panels
- Durable Polycarbonate Windows cover all LEDs on Outdoor Boards

Manual Overview

This manual is intended for the use of the All American Scoreboard owners and users. Read this manual carefully before starting the equipment.

This manual contains important information for operation and maintenance of the equipment.

It also contains important instructions to prevent accidents, personal injury and/or serious damage prior to or during operation of the equipment.

Familiarize yourself thoroughly with the function and operation of this equipment and strictly observe the directions given.

If you have any questions or need further details on specific aspects related to the AAS system, please do not hesitate to contact us. Contact information is listed in Technical Support section.

Topics Covered in This Manual

- Safety Information: An explanation of equipment, environmental and operating safety issues.
- Specifications: General specifications and requirements.
- Quick Reference Troubleshooting Chart.
- Technical Support: Contact information for AAS technical issues and questions.

In this manual you will find three levels of flagged notes or warnings.



WARNING! THE WARNING MESSAGE IS USED WHEN A LIFE THREATENING SITUATION MAY ARISE OR PERSONAL INJURY CAN RESULT.



CAUTION! The caution message is used when there is a danger of damage to the equipment, materials, or other important information; such as Warranty issues.

NOTE: The Note message is used to give operational information and useful tips.

Warranty

Five Year Limited Warranty

Non-compliance with procedures of Installation, Safety, Operation and/or Maintenance practices defined in this manual may result in a Warranty issue.

This warranty extends to and is enforceable by only the original consumer purchaser and only for the period (during the applicable term) which the product remains in the possession of the original consumer purchaser. "Original consumer purchaser" means the person who first purchased the product covered by this warranty other than for purpose of resale. This warranty does not apply if it is found that at *any time* the equipment has not been used for its intended purpose.

NOTE: Please ask your dealer, distributor or sales representative for details.



CAUTION! Any unauthorized changes or modifications to this unit without our prior written approval will void the user's warranty and will transfer health and safety obligations to the user



CAUTION! Changes or modifications to this unit not expressly approved by the party responsible for compliance could void the user's authority to operate the equipment

NOTE: This equipment has been tested and found to comply with the limits for a class "A" Digital device, pursuant to part 15 of the FCC rules. These limits are designed to provide reasonable protection against harmful interference when the equipment is operated in a commercial environment. This equipment generates uses and can radiate radio frequency energy and, if not installed and used in accordance with Owner's Manual, may cause harmful interference to radio communications. Operation of this equipment in a residential area can cause harmful interference in which case the user will be required to correct the interference at their expense.



Table of Contents

Introduction	i
Manual Overview	ii
Warranty	iii
Table of Contents	iv
1.0 Safety Information	5
2.0 Scoreboard Features	6
2.1 Scoreboard General Description.....	6
2.2 Control Interface Systems.....	7
2.2.1 RF Configuration	7
2.2.2 Hard-wire Configuration	7
2.3 The Controller Assembly.....	7
2.4 Cooling System.....	7
2.5 Corrosion Protection	7
3.0 Specifications	
3.1 Specification Table I.....	8
3.2 Wiring Diagrams	8
3.3 Controller Assembly Parts List	9
3.4 Controller Assembly Wiring Diagrams	10
3.5 Controller Board Versions.....	11
3.6 Controller Board Upgrade.....	12
4.0 Assembly and Parts List	13
4.1 Junction Box Wiring Diagrams.....	14
5.0 Troubleshooting	17
5.1 Table II Problem/Cause	18
5.2 Repair and Troubleshooting.....	19
5.2.1 Display Driver Replacement Instructions	21
5.2.2 Driver Board Processor IC Component Exchange.....	22
5.2.3 Direct Connection of Consoles to Scoreboards	23
6.0 Technical Support	
6.1 Customer Service	24
6.2 Contact Information.....	24

1.0 Safety Information

The owner of the All American Scoreboard is responsible for safe operation and repair. The owner, therefore, is obliged to familiarize operating personnel with the contents of this manual and make them aware of all possible hazards.

NOTE: When using this equipment, always follow the manufacturer's instructions for safe operation. In case of emergency, please telephone Technical Support or a qualified service technician.

Do not operate the sign until it is completely assembled and installed per the instructions supplied by AAS.

AAS recommends that your main power be installed by a licensed electrician in accordance with the local building and electrical codes.

All equipment must be grounded in accordance with the local building and electrical codes. AAS recommends Earth Link Ground.

If any part of the Scoreboard equipment is malfunctioning or has been damaged, cease operation and consult with AAS Technical Support or qualified service technician before further use.

Use only AAS specified or recommended replacements parts.



WARNING! USE A LOCK OUT/TAG OUT ON CIRCUIT BREAKERS OR "POWER ON/OFF" SWITCHES WHEN PERFORMING INSTALLATION,

When performing repairs be mindful of the weather and work area conditions. Avoid the unit's exposure to the elements, water and debris, or anything that may be dangerous or cause damage to the equipment.



WARNING! OPERATION OF THE UNIT WITH THE ELECTRICAL CIRCUITRY EXPOSED IS DANGEROUS. BE SURE ALL TOOLS AND ANY OTHER MATERIALS ARE REMOVED FROM THE UNIT, AND ALL ACCESS COVERS ARE REPLACED AND CLOSED BEFORE POWER IS TURNED ON.



CAUTION: Use of solvent cleaners or a power washer on your Scoreboard may cause permanent damage.

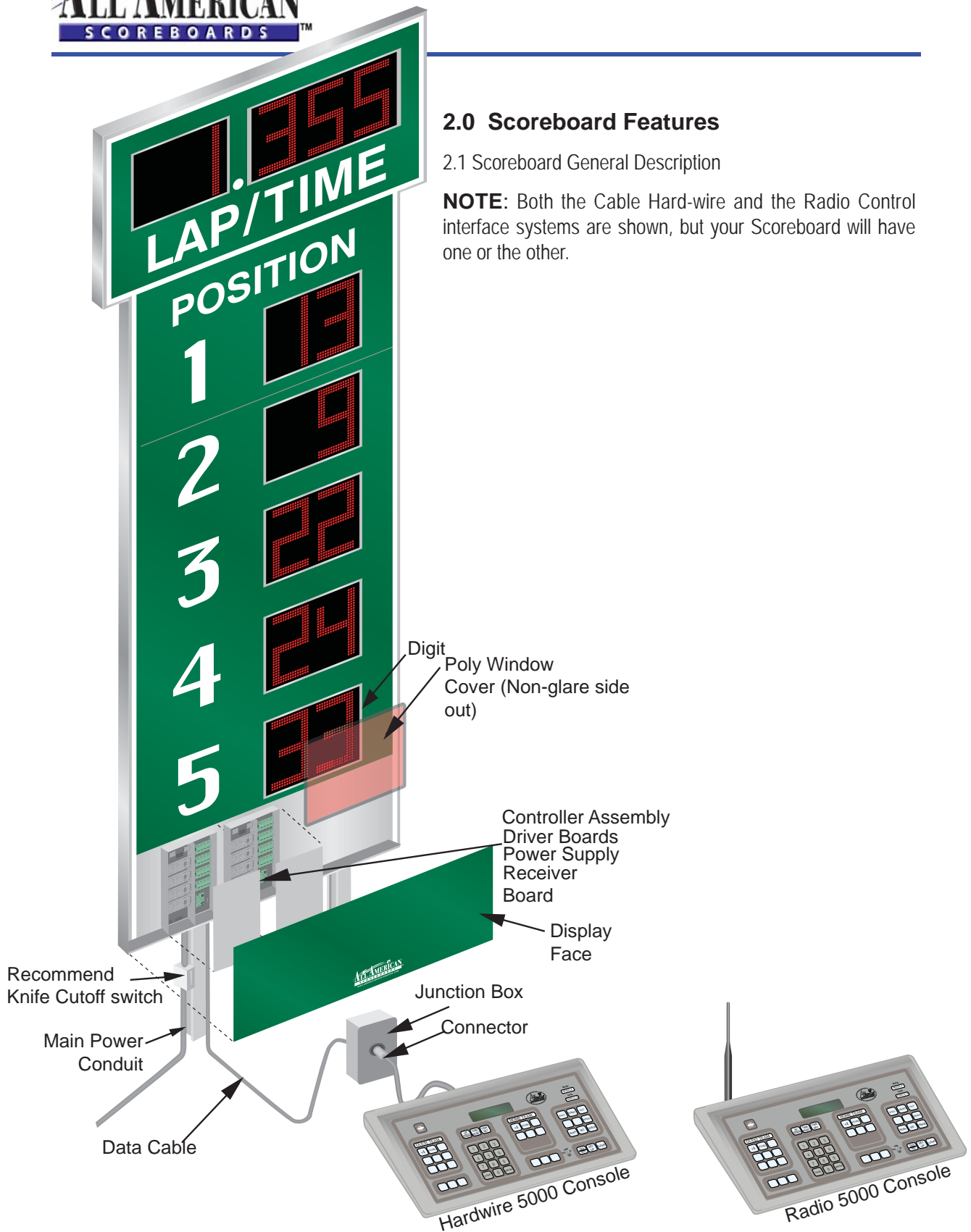

2.0 Scoreboard Features

2.1 Scoreboard General Description

NOTE: Both the Cable Hard-wire and the Radio Control interface systems are shown, but your Scoreboard will have one or the other.

Figure 1: General Assembly of Scoreboard System

There are two operator interface systems, a hard-wire cable system and a radio control system. The systems are described in Section 2.2 and the instructions on how to input data is described in the operations manual. Become familiar with your interface system.

2.2 Control Interface Systems

The two remote control interfaces available:

- Radio Frequency (RF) control system
- Hard-wire control system

2.2.1 RF Configuration

The RF has a 2.4 Ghz, Frequency Hopping Radio that is set up site specific to insure that no interference will occur. The Scoreboard control is managed by the Keypad/Console that has a RF signal setting to communicate the game status displayed and dimming levels for day or night.

2.2.2 Hard-wire Configuration

The hard-wire is actually two communication pairs; one that sends data to the controller assembly from the Keypad Console and one that provides power to the Keypad Console. The Keypad plugs into a junction box.

2.3 The Controller Assembly

The Scoreboard Controller Assembly located in the Scoreboard Cabinet handles various system functions. It receives instructions and game settings to be displayed via the interface configuration (RF or hard-wire). It controls the Digits by sending data to the Driver Boards located within the assembly.

2.4 Cooling System

The system consists of two fans within each module, blowing external air across the components and forcing the hot air out of the module.

2.5 Corrosion Protection

All the PC Board assemblies are conformal coated and all critical connectors have gold-plated pins.

3.0 Specifications

3.1 Specification Table I

ITEM	DESCRIPTION
Overall Dimensions	264" (22') High x 108"(9') Wide x 4" Deep
Display Information	Lap/Time - Minuets/1/1000 second, Car Numbers for 5 positions
Digits	Bright red LED's Digit Size: 21"
Captions	12" high white lettering
Scoring Range	Top 5 Positions
Timing Range	99.999 sec
Cabinet	Extruded aluminum .078" thick
Display Face	Tuffak XL
Service	Front component access, plug-in modules
Control Console	Molded, high impact, micropocessor controller, membrane keypad
Data Cable (Hard-wire system only)	Shielded Twisted Pair (2)
Power Requirements	120 volts, 3 Amps, 60 Hertz, recommend 1-20 amp circuit.
Installation	2 post mounting
Junction Box	3" x 5" hinged with connector

3.2 Wiring Diagrams

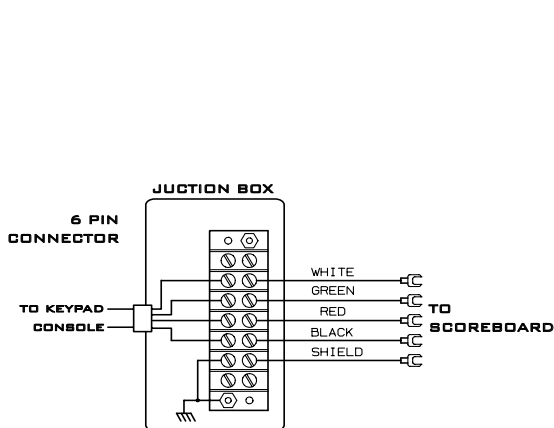

Figure 3: Junction Box
(Cable Hard-wire System only)

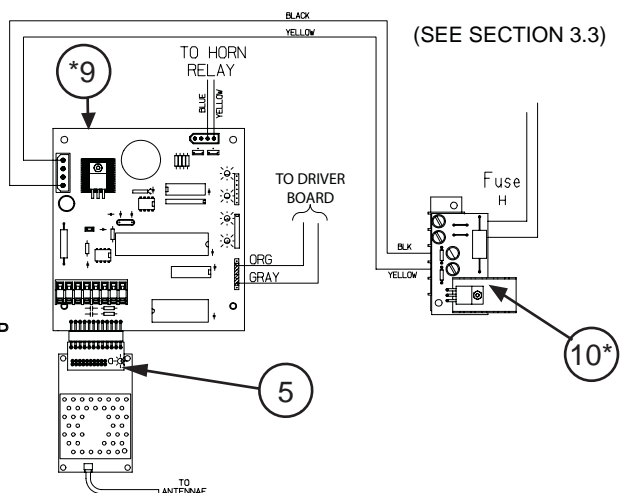
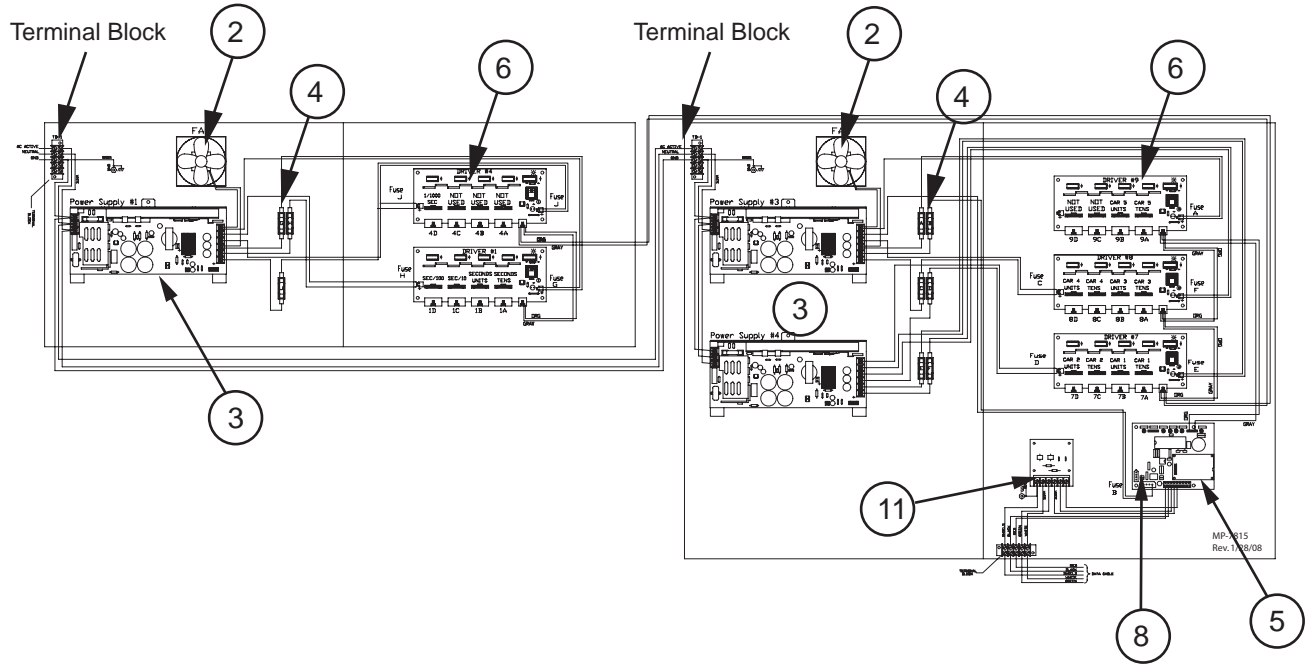

Figure 4: Version 2 Controller Board

3.3 Controller Assembly Parts List



ITEM	No. REQ	MFG P/N	DESCRIPTION
	1	152192	Controller Assembly (Radio -7478R)
	1	152191	Controller Assembly (Hardwire)
2	2	EL00551P	Fan 24V/40 CFM 3
3	3	BL00059P	Power Supply
4	9	7001011	Fuse
5	1	EL00771P	Radio Receiver* (Radio Units Only)
6	5	EL00852P	Driver Board
7	1	EL00525P	Horn Relay, Additional: Socket #703118, Bracket #151728
8	1	EL00863	Controller Board (Version 4, Version 3 requires same wiring)
9	1	151976	Controller Board*(Version 2 - See Figure 4)
10	1	152000	Voltage Regulator *(Only with First Edition Controller Board)
11	1	118522	Lightning Protector (Hardwire)

*See Section 3.4 for further details on Controller Board Versions and wiring diagrams.

Figure 5: Controller Assembly Wiring Diagram and Parts List

3.4 Controller Assembly Wiring Diagrams

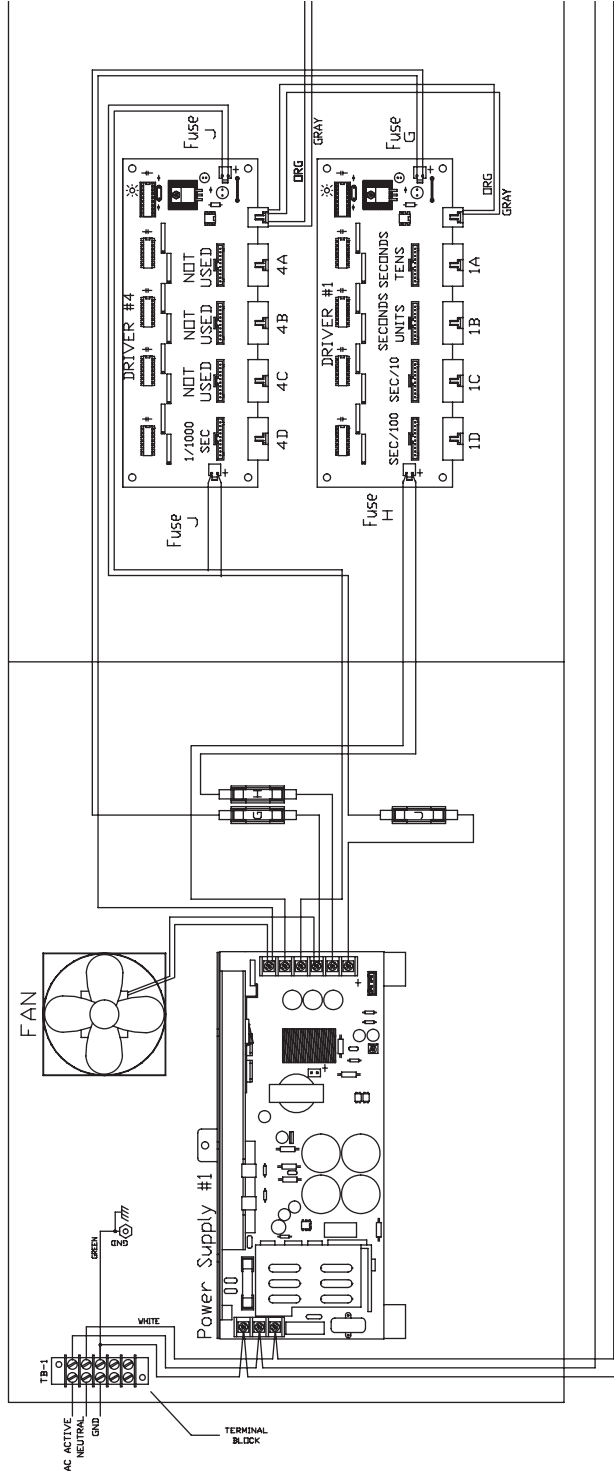

MP-7814
LEFT SIDE

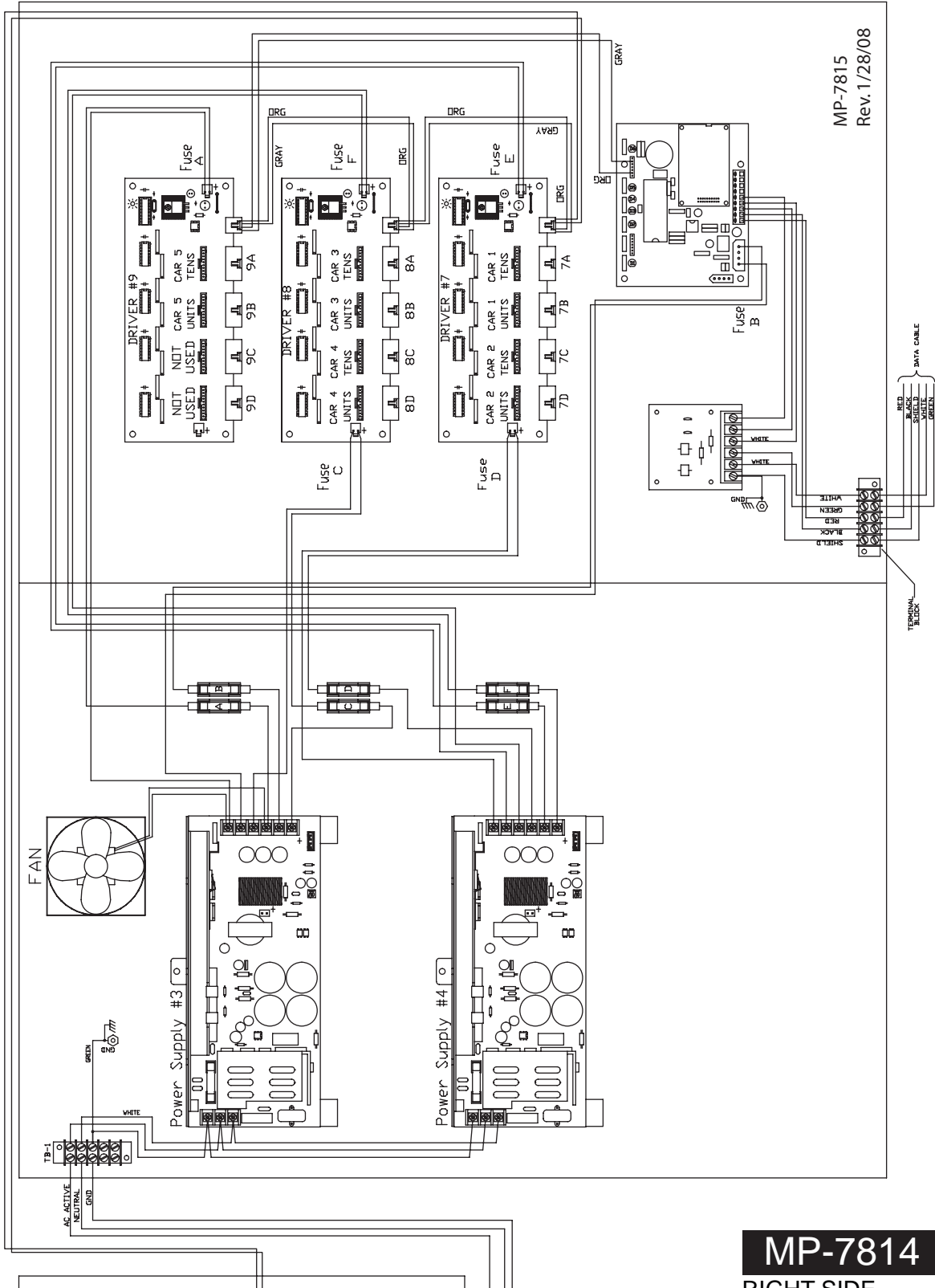

MP-7814
RIGHT SIDE

3.5 Controller Board Versions

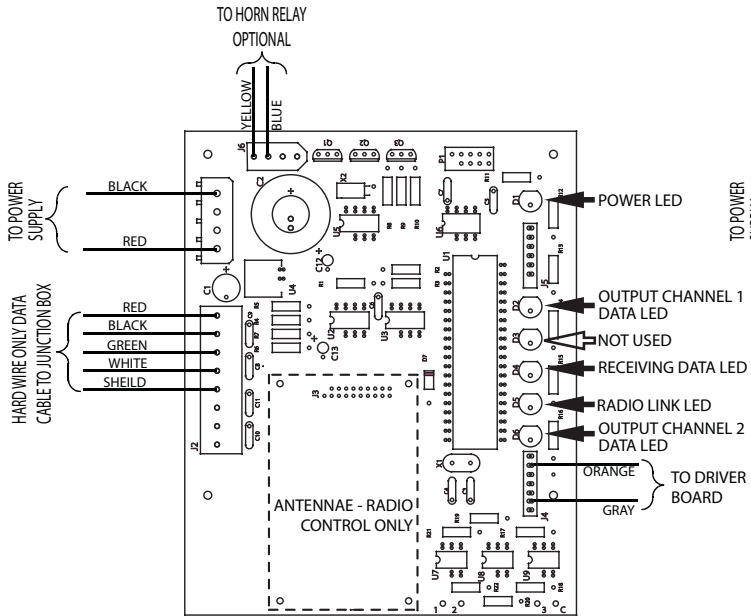

CONTROLLER BOARD VERSION 4

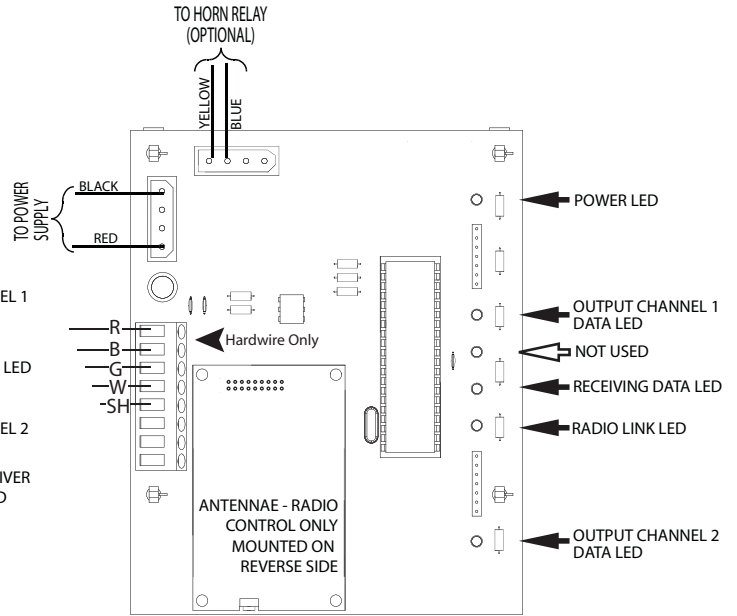

CONTROLLER BOARD VERSION 3

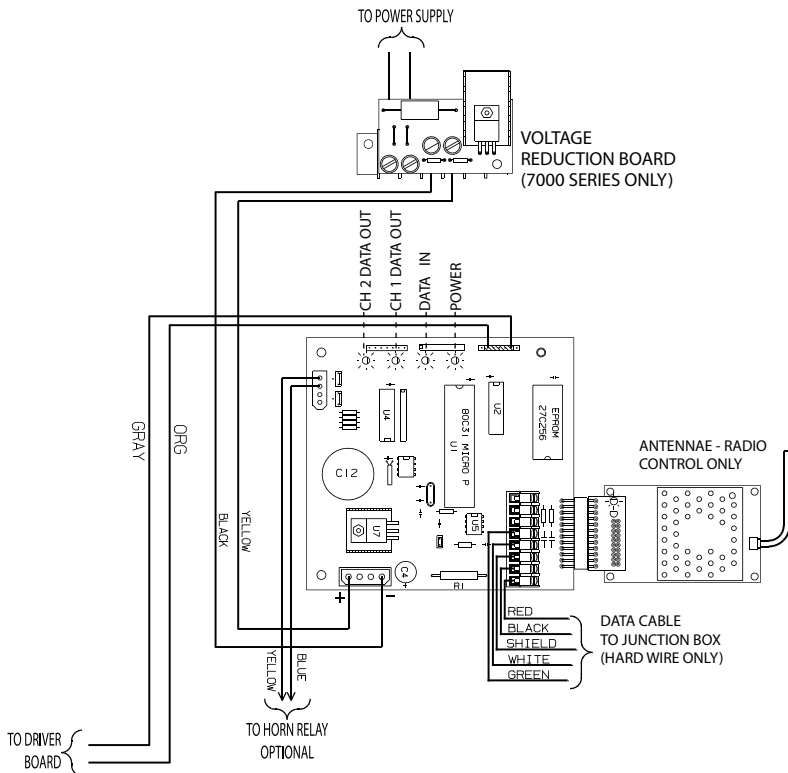

CONTROLLER BOARD VERSION 2

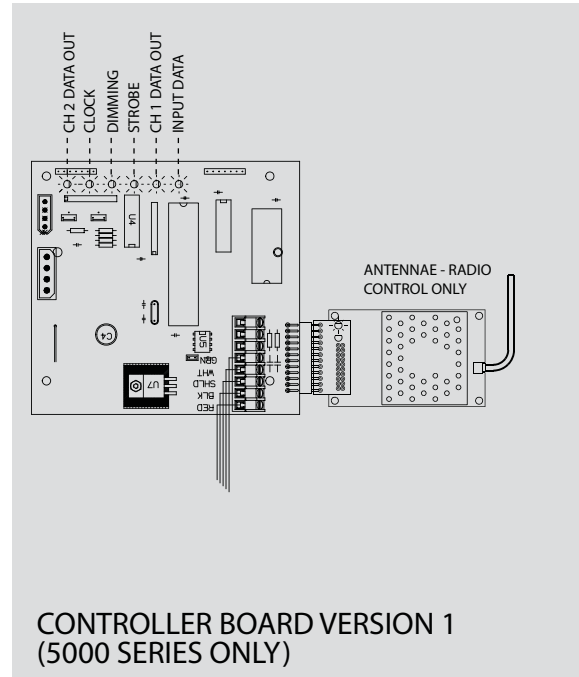

CONTROLLER BOARD VERSION 1 (5000 SERIES ONLY)

3.6 Controller Board Upgrade

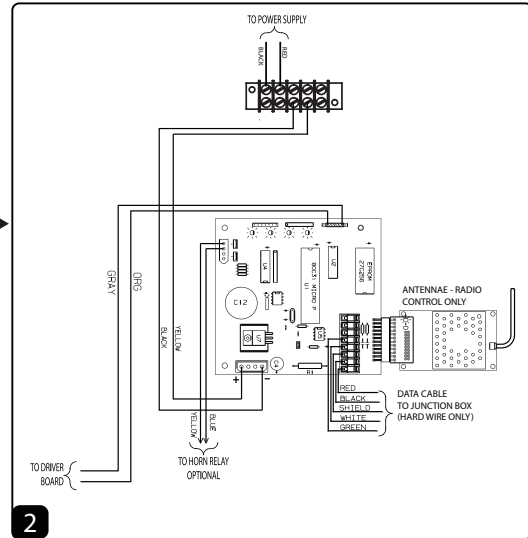
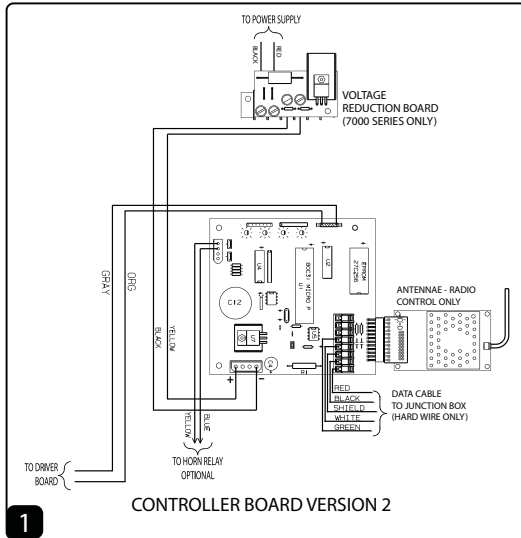

Remove Voltage Reduction Board from terminal block.



WARNING! Use a Lock Out/Tag Out on circuit breakers or "Power On/off" switches when performing installation, repairs or maintenance.

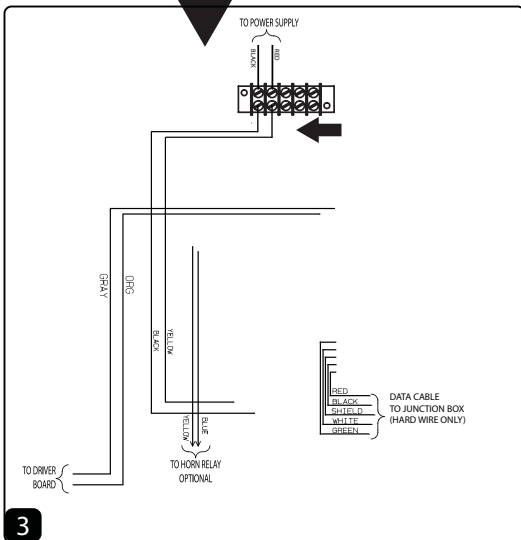

Remove Old Controller Board and re-route yellow and black wires on terminal block to connect to wires to Power Supply, yellow to red and black to black.

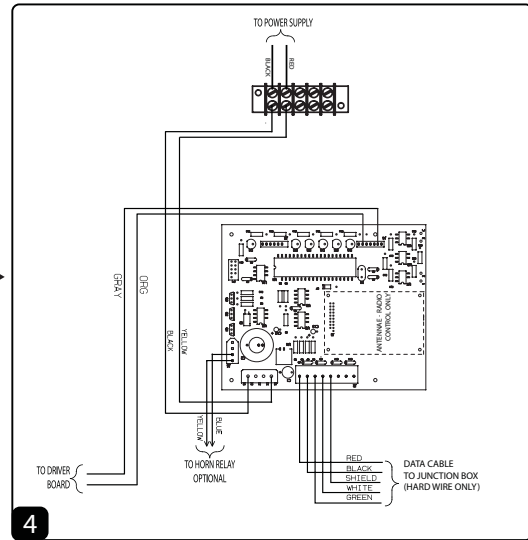

Replace new Controller Board and re-route all wires and connectors as shown. If applicable, remove Antenna from old Controller Board and mount Antenna to new board.



WARNING! RADIO ANTENNA

Snap in connector **MUST** be pushed **STRAIGHT** into connect, or pulled **STRAIGHT** off to disconnect. Any force applied in an upward direction from the plate will break the connector.

4.0 MP-7814 Assembly and Parts List

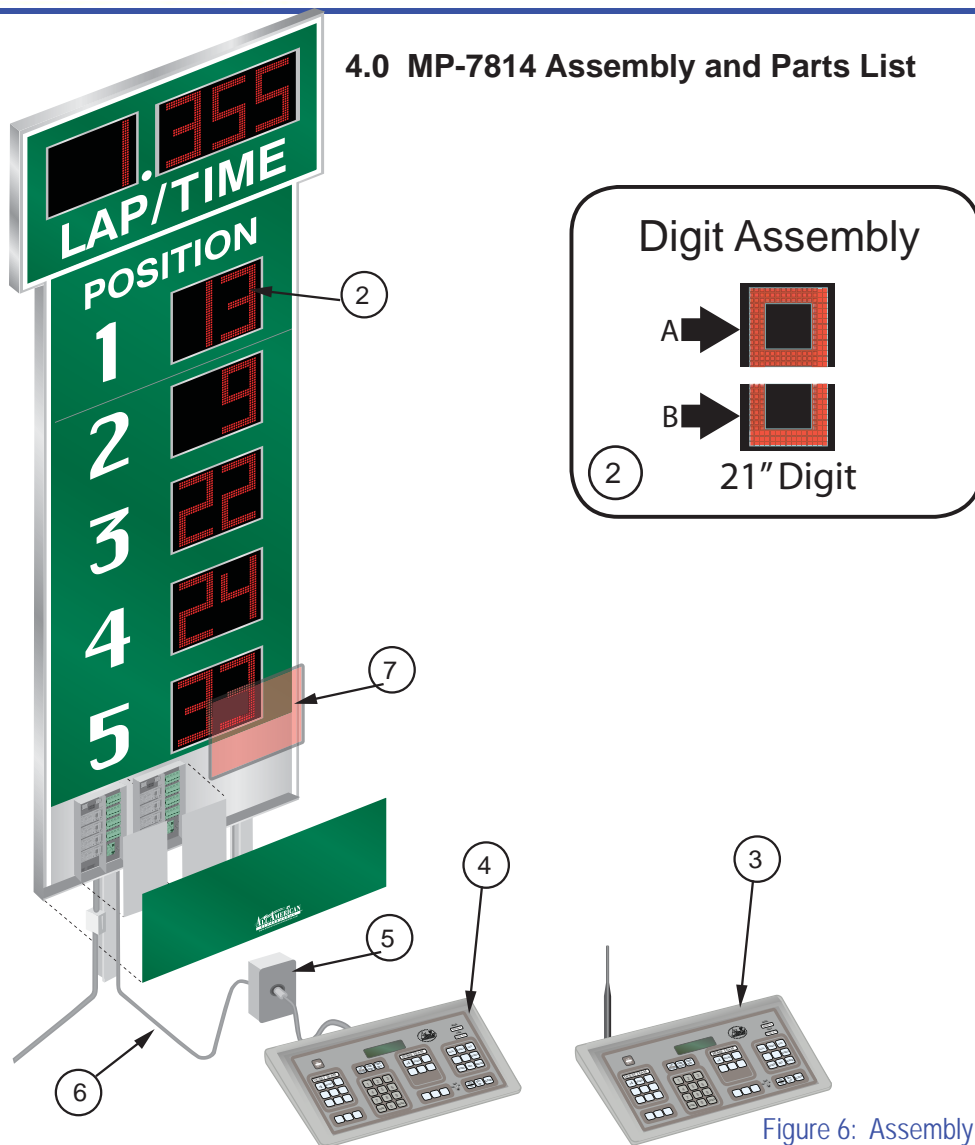
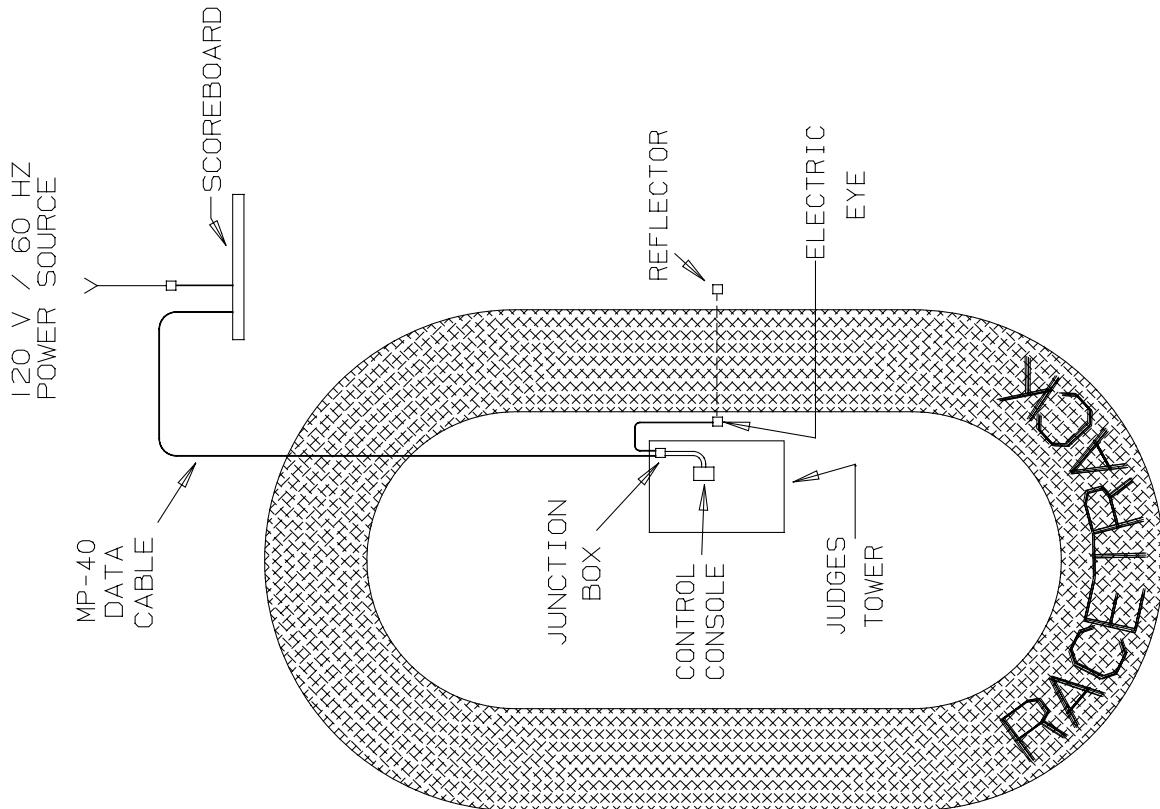
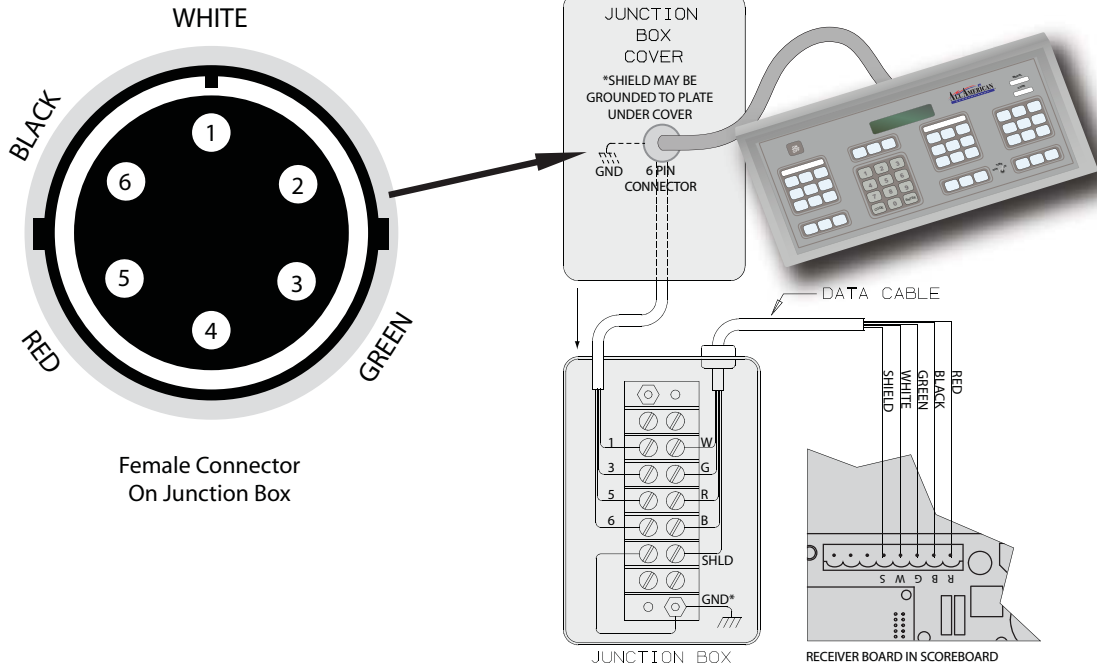

Figure 6: Assembly and Parts List

ITEM	No. REQ.	MFG P/N	DESCRIPTION
1	1 - RF System only	EL00770P	Radio Antenna 2.4 GHZ 5Db
2	4		Digit 21" Red
2a	4	LED5M24AR	Top 21" Red Digit
2b	4	LED5M24BR	Bottom 21" Red Digit
3	1 - RF System only	C5000RB	Keypad Console RF
4	1 - Hardwire System Only	151735	5000 Keypad Console (Hardwire)
5	1 - Hard-wire system only	151915	Junction Box, with connector
6	1 - Hard-wire system only	AS REQ.	Hard-wire cable harness
7	10 (Match to Digit)	Various	Poly Window Cover Sheet Poly

4.1 Junction Box Wiring Diagrams

Single Scoreboard Wiring



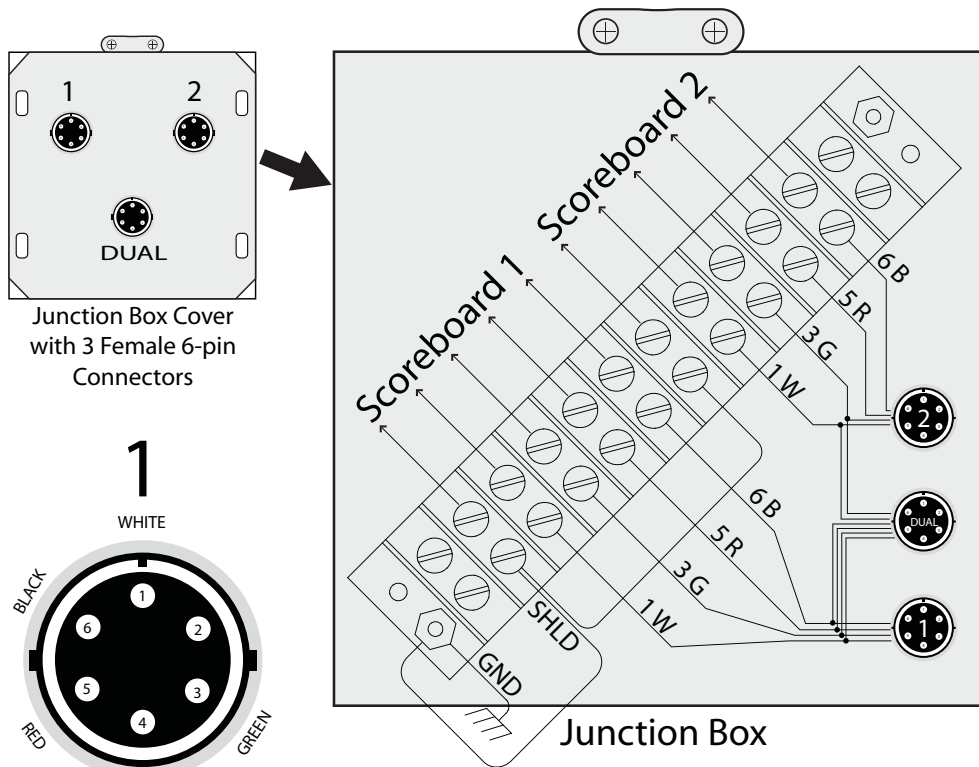

Male 6-Pin Connector from Keypad Console.
NOTE: Pins 1&2 and pins 3&4 in male 6-pin will be jumped (Pins Count Counterclockwise)

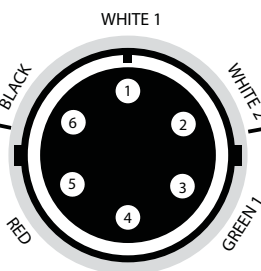
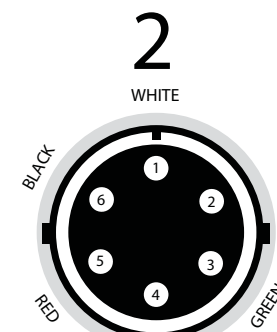
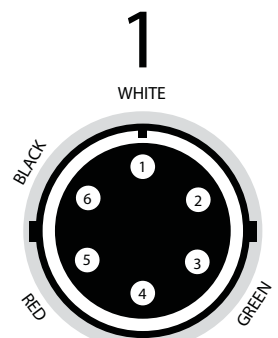

When wiring 2 Scoreboards together, use a Dual Junction Box. The scoreboards will be able to be controlled separately or simultaneously.

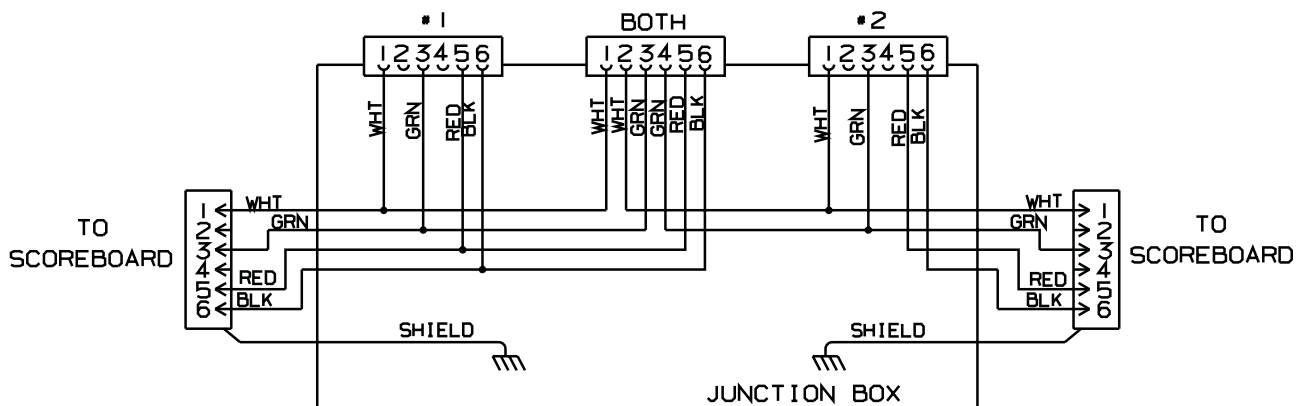

The key components of a scoreboard are Display Digits/Indicators Boards, Controller (Signal Receiver) Boards and Power Supplies. The Display Driver Boards and Controller Boards are grouped as part of an in-closed Controller Assembly inside the Scoreboard. The Power Supply Assembly is located next to the Controller Assembly also in-closed (See Figures 5 and 6).

The Display Digits/Indicators are circuit boards made up of low DC voltage Light Emitting Diodes (LED's) with a connector on the back of the board. Larger digits (21 inches and up) are made on two or more circuit boards that plug in to each other.

The LEDs are organized into segments (the bars that make up a numeral), and the segments are made of strings/groups/clusters of individual LED's in a circuit together. If one LED fails, it will most likely appear that a group has failed. **Should an entire Digit or Indicator Board not light, it is more likely to be a Driver Board or wiring problem than a failure of the Digit Board itself.**

Driver Boards are mounted in groups as part of the Controller Assembly. The number of drivers will depend on the number of displays in the Scoreboard. Some of the larger Scoreboards will have a second assembly that only has Driver Boards.

Each driver board will run 4 Digit Displays; there are eight 10-pin connectors for digit data connections (4 pairs of 2 duplicates). Each digit connector controls one Digit, or may be used to control several indicators.

Data comes into the Driver Board through the 4-pin connector, and is resent to the next driver using daisy chain wiring harness. If one Driver Board should lose power or experience a failure, no data will be sent to any boards that follow it in the daisy chain. It is quite easy to tell if a Driver Board is getting data, since the LED will be flashing. The program chip located in the corner of the Driver Board is preset at the factory to tell it what data it is supposed to display. For more information on Driver Board troubleshooting, see section 6.2.1.

There are two 2-pin power connectors on each end of a Driver Board (one board will run two Digits). **If you have two Digits that don't light at all, check their power connectors.** Check the wiring diagrams to see how the Digits are connected.

Every Scoreboard has one Receiver Circuit Board (Controller). There are two basic configurations of Controller Boards (See Figures 4 and 5), each with 2 versions (See Section 3.5). It is possible to replace an older style (Version 2) Controller Board with the latest (Version 4) Controller Board by removing the Voltage Reduction Board and wiring the power wires from the Controller Board together with the wires going to the Power Supply at the Voltage Reduction Board Terminal Block (see section 3.6). All other connections can simply be plugged back in according to wiring diagrams after a new Controller Board is mounted.

All Series 7000 Receiver Boards accept the same inputs and generate the same outputs and can be freely interchanged. Older style Controller Assemblies wired the Driver Boards to the Controller Board by starting from the closest Driver Board and daisy chaining to the further

Driver Boards. Newer Controller Assemblies uses longer wires to connect the Controller Board to the furthest Driver Board. Both methods will produce the same results, but the longer wires allow for easier troubleshooting of Driver Boards (the shorter wires cannot reach the furthest Driver Board from the Controller Board). Without checking the Driver Board directly from the Controller Board, it is difficult to pinpoint which Driver Board, if any, needs to be replaced.

The number of power supplies will vary with the number of Digit displays in the Scoreboard. The Power Supply Assembly is inside the scoreboard located next to the Controller Assembly. The Power Supply Assembly includes cooling fans that are used to help move the air through the assembly. **Power Supplies do not often have failures, however they will turn themselves off if overheated.** You have to shut down, let them cool and reapply power. The Power Supply outputs are equipped with fuses. The fuses are readily available and can be found at the local hardware store. Be sure to match the Amp rating.

5.0 Troubleshooting

This section gives maintenance and troubleshooting information. Included are troubleshooting guides for typical Scoreboard malfunctions.



WARNING! USE LOCKOUT/TAG OUT ON CIRCUIT BREAKERS OR "POWER ON/OFF" SWITCHES WHEN PERFORMING INSTALLATION, REPAIRS OR MAINTENANCE.



CAUTION: When re-installing a connector it is extremely important to get the connector on properly. Push or pull the connectors **STRAIGHT** on or off. Misalignment of a pin or connecting backwards will cause permanent damage.

NOTE: When troubleshooting always double check connections.

NOTE: Turning the system off and on again (reboot) may solve some issues.

NOTE: If dampness is present around the PC boards, use of a hair dryer or blower can help in the drying. Take care not to over heat or apply high pressure air volume.

NOTE: Printed circuit board problems and troubleshooting should be done at the factory.

A simple analog or Digital voltmeter will be sufficient for all user repairable problems.

5.1 Table II Problem/Cause

PROBLEM	POSSIBLE CAUSE	SOLUTION
Scoreboard doesn't light and Console doesn't work	No power to the Scoreboard	Check that the main circuit breaker is on.
		If this is a first test new installation, recheck the electrical hook-up connections.
		Check for 110 VAC at the Scoreboard voltage connections.
	No power out of the controller assembly	Check for defective or blown fuses in the controller assembly, and replace as needed.
		Check for 24 VDC at the power supply terminals in the controller assembly.
		Check for 12 to 16 VDC on the red and black wires at the data cable terminal block in the controller assembly.
Scoreboard Digits don't light (Console Works)	No power out of the controller assembly to the Digit Board	Check all the connections in the controller assembly
		Check for defective or blown fuses in the controller assembly, and replace as needed.
		Check for 24 VDC at the power supply terminals in the controller assembly.
		Check if LED on the Receiver Board is lit. If not, check power supply connection.
		Check that the LED on the first Driver Board (closest to Receiver) is flashing. If not, check the data cable connections (orange and grey wires) from the Receiver to the Drivers, and check the power connection to the Driver Board.
		If the Driver Board LED is still not flashing, connect a different Driver Board to the Receiver Board (first in line). If the LED is now flashing, the first Driver Board should be replaced. If not the problem is on the Receiver Board.

PROBLEM	POSSIBLE CAUSE	SOLUTION
Scoreboard Digits light Console Doesn't Work (also see Console direct connection instructions)	No Power to the Console - For a cable hard-wire system	Check the Console connector at the Junction Box.
		Check for 12 to 16 VDC between the red and black wires in the junction box. If there is power, turn on and code in the Console, even if it may not appear to be working. Listen for beep sounds when pressing the keys, and see if the Scoreboard responds at all.
		If there is no power at the junction box check the red and black wires at the terminal block in the controller assembly
	No Power to the Console - For wireless RF system	Check the output of the wall transformer by unplugging it at the Console, putting the + volt meter lead into the center cavity of the power plug and touching the meter lead to the metal shell. The reading should be at least 10 VDC. If there is power, turn on and code in the Console, even if it may not appear to be working. Listen for beep sounds when pressing the keys, and see if the Scoreboard responds at all.
Check the LED on the radio adapter Board inside the Scoreboard. If it is lit, turn the Console off. This LED should go out about 5 seconds later; turning the Console on again should relight the LED.		
	Power is OK but Console is not on	Check the keypad connection to the main Board in the Console is good.
Digits light, Console works, but no control of the Scoreboard (also see Console direct connection instructions)	No data signal established	Turn off the Scoreboard and the Console and turn the Scoreboard on then the Console. Retry coding Console.
		Start with the Driver Board closest to the Receiver Board, check that LED on each Driver Board is flashing. If not, check the data cable connections (orange and grey wires) from the Receiver to the Drivers, and check the power connection to the Driver Board.
	Bad data line connection (Cabled System)	Check the Console cable connection. Check for 1 to 4 volts AC on the green and white wires at the junction box. Retry coding Console.
	Low battery (Wireless Consoles)	Be sure the battery is charged (if so equipped), or try the wall transformer to power the Console.
	No RF signal established (Wireless Consoles)	Take Console 10 to 25 feet from the Scoreboard and test again. Check antenna connections and tighten if necessary, both in the Scoreboard and in the Console.

PROBLEM	POSSIBLE CAUSE	SOLUTION
Scoreboard works, but some lights stay on all the time	Short in Digit circuit	Check the Digit and cable assembly for shorts to the Scoreboard frame or other ground and to the power leads on the Driver Board.
The Scoreboard works, but some lights do not come on or blink	Bad Connection	Check the wiring connection on the bad Digit Boards and Driver Boards.
	Bad Driver or Digit Board	Switch Driver Board connection of bad Digit Board to a known good Driver Board. If Digit works replace Driver Board, if not replace Digit Board.
	Bad Driver and Digit Board	Plug the bad Digit into another output position. Using the SAME Driver Board. If the same lights remain on, replace Driver and Digit Boards.
The Scoreboard works but some Digits do not come on	Power connection	Check the LED on the corresponding Driver Board. If the LED is blinking check the power connection at the opposite end of the Board for 24 VDC. If not check the power and data cable connections on the Driver Board.
	Digit cable	Plug the blank Digit into known good Driver Board. If it's still blank, check for bad cable or cable connections. If cable is good, replace Digit.
	Bad Driver Board	Disconnect the bad Digit and connect known good Digit in its place on the Driver Board. If the good Digit is now bad replace the Driver Board.
Console beeps but no display	Bad display connection	In the Console, check the ribbon cable between the main Console Board and the display module.
Console has erratic operation or display	Bad IC connection	In the Console check the IC chip is well seated in its socket and socket leads look good.



WARNING! OPERATION OF THE UNIT WITH THE ELECTRICAL EXPOSED IS DANGEROUS. BE SURE ALL TOOLS AND ANY OTHER MATERIALS ARE REMOVED FROM THE UNIT, AND ALL ACCESS COVERS ARE REPLACED AND CLOSED BEFORE POWER IS TURNED ON.

NOTE: If the cause of a problem cannot be determined, please contact the Customer Service Department

5.2 Repair and Troubleshooting

NOTE: In emergency situations (Tournament begins in an hour), the following steps may help to make the Scoreboard usable in a temporary fashion. These procedures are best performed by someone who has experience working on electronic equipment. If possible, consult with customer service before proceeding.

All of the Driver Boards in a 7000 series Scoreboard are interchangeable. However, each Board has an address programmed inside its microcontroller chip. The chip from the Board being replaced must be put into the new Board for proper operation. Example: The scoring Driver of a football Board has a problem. The Ball On/Yards To Go Driver can be used in its place. (Ball On and Yards To Go will not be usable until a new Driver Board is received from the factory).



WARNING! OPERATION OF THE UNIT WITH THE ELECTRICAL CIRCUITRY EXPOSED IS DANGEROUS. BE SURE ALL TOOLS, ANY OTHER MATERIALS ARE REMOVED FROM THE UNIT, AND ALL ACCESS COVERS ARE REPLACED AND CLOSED BEFORE POWER IS TURNED ON.

5.2.1 Display Driver Replacement Instructions

NOTE: See Owner manual for additional specifications, wiring diagrams, and site setup.

STEP 1: Shut off power to the sign at the site circuit breaker box.



WARNING! USE A LOCK OUT/TAG OUT ON CIRCUIT BREAKERS OR “POWER ON/OFF” SWITCHES WHEN PERFORMING REPAIRS OR MAINTENANCE.

STEP 2: Remove Scoreboard face at the Controller Assembly location (See Figure 1)

STEP 3: To access the Controller Assembly remove cover and set aside the cover and the PH screws.

STEP 4: Examine the condition and familiarize yourself with the existing, installed Display Driver Circuit Board and connectors (See Figure 4).

NOTE: It will be easier to disconnect the old Display Driver Board connectors before removing it from the assembly box.



CAUTION: Do not pull on the wiring of the connectors when disconnecting. Grab the connector body and, using your thumbnail, put slight pressure on the center locking clip and pull out.

STEP 5: Disconnect one connection and reconnect to the replacement board in the same location before disconnecting the next connector. Continue this process until all connections have been transferred to the new Display Driver Board and set aside in a safe place.

STEP 6: After all the connectors have been moved to the new Display Driver Board, remove the old board by using a flat screw driver; press in the clip on the stand-off, put your thumb on the mounting stand-off of the board (4 places), apply upward pressure on the board with your fingers (See Photo 1).

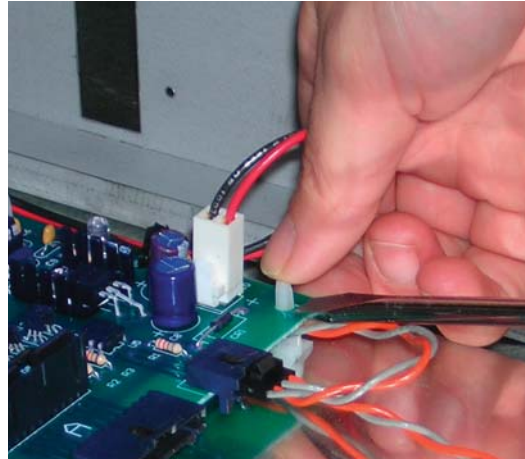

STEP 7: Install the new board on the existing standoffs in a reverse process.



CAUTION: It does not require a lot of pressure to remove or install the Display Driver Boards; take care not to damage the board or stand-off with tools.

Photo 1: Board Stand-Offs

NOTE: Make sure the board snaps back on the standoffs and is secure.

STEP 8: Replace the assembly cover that was removed in Step 3 using the PH screws you set aside.

STEP 9: Unlock and turn main power circuit breaker on to test for proper operation of the Scoreboard (Section 3.0 of owner's manual for Keypad Functions).



CAUTION: Consider environmental conditions before powering up an open Cabinet.

5.2.2 Driver Board Processor IC Component Exchange

STEP 1: Remove the bad Driver Board as described in previous instructions.

STEP 2: Remove the processor chip from the new Driver Board by gently pulling STRAIGHT up.

NOTE: It is suggested that you label any and all components being removed before removing.

STEP 3: Carefully take the processor chip out of the old Driver Board by gently pulling STRAIGHT up and install the IC in the replacement Board. Be sure the notched end of the chip is aligned correctly.

NOTE: Put the processor chip from the new board into the defective Driver Board so it doesn't get lost.

5.2.3 Direct Connection of Consoles to Scoreboards

NOTE: This can be useful when troubleshooting to ensure that the electronics are working properly. For radio controlled systems, skip to STEP 8.

STEP 1: For a hard-wired system, open the junction box and disconnect the connector wires at the terminal block in the box.

STEP 2: Take the box cover plate with connector up to the Scoreboard. Attach the red and black wires to the matching positions on the terminal block on the Receiver Board. (disconnect the red and black data cable wires that go to the junction box).

STEP 3: Attach the green and white wires from the cover plate connector to the terminals on the Lightning Protector Board where the same colored wires connect to the Receiver Board.

STEP 4: Disconnect the data cable (to the junction box) green and white wires from the Lightning Protector Board. Mark the board so that the wires can be put back on the correct terminals.

STEP 5: Test the system. If it works, move the green and white wires from the cover plate connector to the other two terminals on the Lightning Protector Board.

STEP 6: Test again. If the Scoreboard works, there is a problem in the data cable somewhere between the Scoreboard and the junction box. If not, the Lightning Protector Board must be replaced.

STEP 7: The data cable can be checked by re-installing the junction box cover plate and connecting both green wires to one of the green wire same with the white wires. While the Scoreboard will operate with the Lightning Protect Board by-passed in this fashion, it should be fixed as soon as possible, since the Board also protects the electronics in the Scoreboard from other sources of potentially damaging interference.

STEP 8: Radio controlled consoles may be connected directly to the Scoreboard through the 12-pin radio connectors. Remove the radios and Interface Boards. Using 22 gauge solid wire, connect pin 10 of the Console connector to pin 10 of the Scoreboard Receiver Board connector. Also connect pin 2 of the Console connector to pin 6 on the Receiver Board connector. Powering the Console from the battery or wall cube, the system should operate. This eliminates any radio related communication problems.



CAUTION: if it is necessary to operate the Scoreboard this way, keep the 2 wires as short as possible (10 ft. max), since there is no protection on these lines and damage to the Scoreboard or Console could result from static or other outside sources.

6.0 Technical Support

6.1 Customer Service

Customer satisfaction is the top priority at AAS. Our skilled, experienced Account Management teams are dedicated to providing highly responsive service through all phases of our client's programs.

These teams are computer-linked to each of our manufacturing facilities to provide "on-line" updates on the status of customer orders. Furthermore, AAS's EDI capabilities allow electronic interchange to efficiently process customer orders.

6.2 Contact Information

All American Scoreboards

401 S. Main Street

P.O. Box 100

Pardeeville, WI 53954

PHONE: 1 800-356-8146

FAX: 1 608-429-9216

Web Site: www.allamericanscoreboards.com